

# QL Today

Volume 11  
Issue 3  
Dec. 2006 -  
Feb. 2007

ISSN 1432-5454

The Magazine about QL, QDOS,  
Sinclair Computers, SMSQ...

## GPS and QPC ...

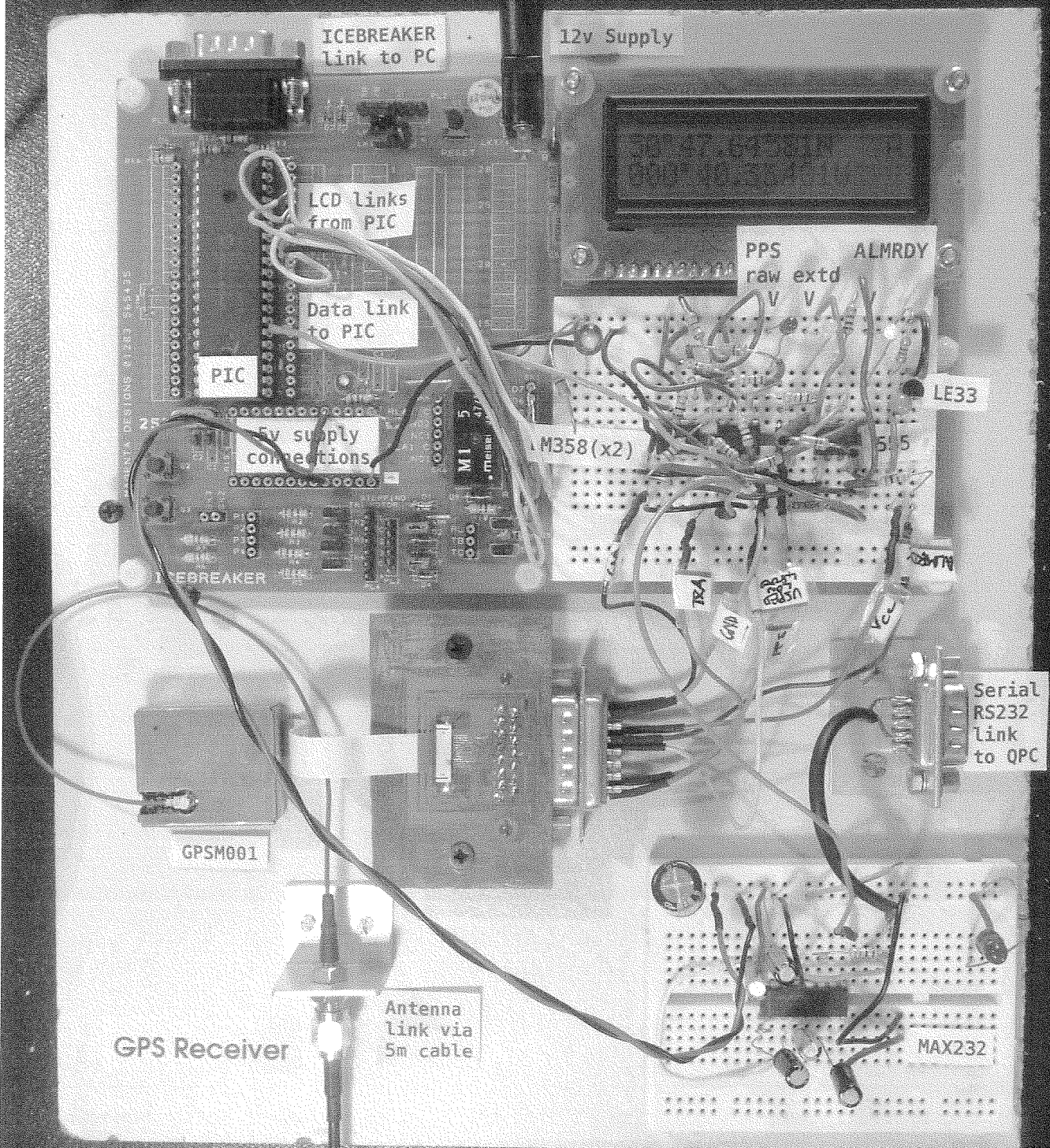

... part 2 continues on page 12!

# Contents

- 3 Editorial
- 4 News
- 8 Gee Graphics! (on the QL ?) - part 47  
*H.L. Schaaf*
- 10 CALLing Machine Code *George Gwilt*
- 12 GPS and QPC - Part 2 *Hugh Rooms*
- 17 Start Here - Part 7  
Essential Information For 21st Century  
QLers *Roy Wood*
- 22 Toolkits *David Denham*
- 26 Bye-Bye Byfleet *Geoff Wicks*
- 30 Letter-Box
- 36 Programming in Assembler -  
Part 17 - or not Part 17! *Norman Dunbar*
- 42 Minimalist 3D Animation *Stephen Poole*
- 43 Do you remember...? - Part 4  
*Ralf Reköndt*
- 46 Byts of Wood *Roy Wood*

# QL Today

ISSN 1432-5454

## German office & Publisher:

Jochen Merz Software    Tel. +49 203 502011  
Kaiser-Wilhelm-Str. 302    Fax +49 203 502012  
47169 Duisburg    email: JMerz@j-m-s.com  
Germany    email: QLToday@j-m-s.com

## English office:

Q Branch    Tel. +44 1273 386030  
20 Locks Hill    Mobile +44 7836 745501  
Portslade    Fax +44 1273 381577  
BN41 2LB    email: qbranch@qbranch.demon.co.uk  
United Kingdom    email: QLToday@j-m-s.com

## Editor:

Geoff Wicks    Tel. +44 1332 271366  
5b Wordsworth Avenue    email: gwicks@beeb.net  
Sinfon    email: QLToday@j-m-s.com  
Derby DE24 9HQ  
United Kingdom

## Co-Editor:

Bruce Nicholls    Tel +44 20 71930539  
38 Derham Gardens    Fax +44 870 0568755  
Upminster    email: qltoday@q-v-d.demon.co.uk  
Essex RM14 3HA    email: QLToday@j-m-s.com  
United Kingdom

**QL Today** is published five times a year, our volume begins on beginning of June. Please contact the German or English office for current subscription rates or visit our homepage [www.QLTODAY.com](http://www.QLTODAY.com).

We welcome your comments, suggestions and articles. YOU make **QL Today** possible. We are constantly changing and adjusting to meet your needs and requirements. Articles for publication should be on a 3.5" disk (DD or HD) or sent via Email. We prefer ASCII, Quill or text87 format. Pictures may be in \_SCR format, we can also handle GIF or TIF or JPG. To enhance your article you may wish to include Saved Screen dumps. PLEASE send a hardcopy of all screens to be included. Don't forget to specify where in the text you would like the screen placed.

**QL Today** reserves the right to publish or not publish any material submitted. Under no circumstances will **QL Today** be held liable for any direct, indirect or consequential damage or loss arising out of the use and/or inability to use any of the material published in **QL Today**. The opinions expressed herein are those of the authors and are not necessarily those of the publisher.

This magazine and all material within is © copyright 2006 Jochen Merz Software unless otherwise stated. Written permission is required from the publisher before the reproduction and distribution of any/all material published herein. All copyrights and trademarks are hereby acknowledged.

If you need more information about the UNZIP program which is used by our BOOT program to unpack the files, we suggest that you visit Jonathan Hudsons web site where you find more information about lots of interesting QDOS software and INFOZIP at [www.bigfoot.com/~jrudson/](http://www.bigfoot.com/~jrudson/)

**The deadline for the next issue is the  
10th of March 2007**

# Advertisers

in alphabetical order

Jochen Merz Software	45
QBranch	32, 33
Quanta	13
RWAP	39
TF Services	21
Geoff Wicks	7

# Editorial

by Geoff Wicks

Recently I have been reading the weblog of a Japanese man. He describes how, a couple of years ago, the new year started inauspiciously when, early on New Year's Day, he was woken from his sleep by the sound of a huge earth tremor.

It reminded me of events some ten years previously. Early in 1995 heavy rains in Switzerland and Germany had swollen rivers in the Netherlands to such an extent that the dikes were in danger of bursting. Hundreds of thousands of people had to be evacuated at short notice from large areas of the country. And it was not just people. There were also vast quantities of livestock and the entire commercial infrastructure that had to be protected.

As a foreigner living in the Netherlands I was immensely impressed by the professional and calm way this logistically complex evacuation had been carried out. But this was not how it felt to the Dutch. The emergency confronted them with their deeply rooted insecurity of living in a land whose existence is constantly threatened by the hostile elements of wind and water. The nation experienced a huge loss of self confidence, which increased in intensity throughout the year.

We QL-ers may not be threatened by the forces of nature, but all too often we see ourselves as being surrounded by a hostile world. Our enemy is commercial forces that constantly threaten the future of our system. Added to that is the problem of slow attrition as our numbers are getting lower and lower.

In recent issues QL Today has not helped to lighten the mood. Last time we reported on the serious fall in Quanta membership, and in this issue we look at the near collapse of UK shows. We pose a question that some readers would prefer us not to ask. We make no apology for this. You do not solve problems by closing your eyes.

In 1995 I felt the Dutch should have been immensely proud of themselves for the way they handled a complex and serious emergency. Instead they lapsed into national depression.

We QL-ers should not fall into this error. We have the right to be immensely proud of ourselves. When the QL was first born all the experts saw it as a sickly child that would certainly die in infancy. Twenty three years on we are an active adult. And, unlike other retro-computers, we have continued to develop our system so it bears little resemblance to the infant it once was.

We would like our readers to see 2007 as a year of challenge. We want you to tell us how you would like to see things change. How should we now reshape our infrastructure - Quanta, traders, shows, internet contacts, software and hardware development and publications - to ensure that we QL-ers remain around for a good few years yet?

## Cartoon

by Roy Wood



*'I was following a tutorial in QL Today and it said "Hit the Space Bar", so here I am!'*

## JUST WORDS! goes Freeware

**Just Words!** has now made all its commercial programs freeware. Full versions of the four commercial programs, QL-2-PC Transfer, QL-Rhymes, Auto-Graph and Pin-Down can now be downloaded from the Just Words! website.

Just Words! was started up in 1994 to market its first program Solvit-Plus following the closure of DJC, although the brand name only came into use about 18 months later. It believes the move to freeware is in line with current trends in the QL community. The commercial sector has become less important, whereas the internet has a greater role in keeping QL activity alive.

Late last year Just Words! completely rewrote its website to facilitate the move to freeware. In this way the brand image and distinctive house style can be preserved.

Just Words! intends to continue to set up a stall at QL shows following the example of former trader Dilwyn Jones. However advertising will disappear from QL Today following the completion of the present contract.

Head of Just Words!, **Geoff Wicks**, adds that his decision was also influenced by his taking over the editorship of QL Today just over a year ago. Geoff Wicks was formerly a member of the Quanta committee, and recent developments in Quanta, which have been reported in the magazine, have reinforced the need to maintain the editorial independence of QL Today. For this reason he also feels that it is better for him to cease commercial trading activities.

<http://members.lycos.co.uk/geoffwicks/justwords.htm>

## WITTEWARE Upgrade

**Per Witte**, whose QL Today articles on aspects of EasyPtr programming have been much appreciated, has recently upgraded his Knoware website.

This site was first set up in 2004 and has now been redesigned in predominantly QL Colours. From the site it is possible to download Per's programs, which are divided into 6 categories Pointer Environment, Games, File/Disk, Toolkits, Go-sub and Utilities. The site also contains several articles he has written over the years.

Although much of the site will be of interest mainly to serious (PE) programmers, other QL-ers will find it worthwhile to explore the Games and File/Disks categories. The former contains the DMiner

program that aroused much interest when demonstrated at the QL is 21 show just over a year ago.  
<http://www.witteware.com/knoware/>

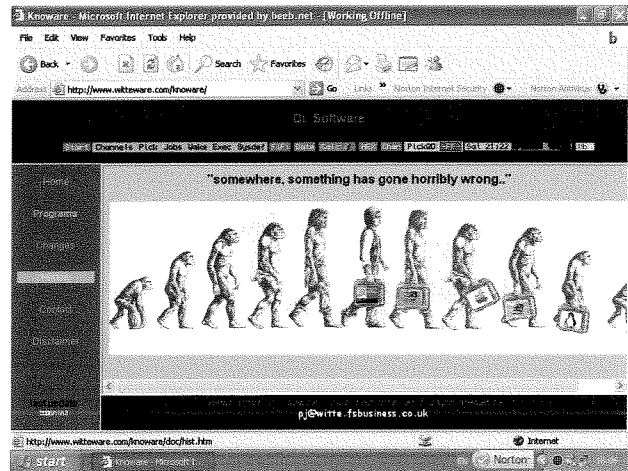

## QL NEWS LIST Closure

Towards the end of November, **Jochen Merz** announced the closure of the QL newslist because of changes in the email system at his provider. He writes:

*"My j-m-s.com mail provider changed its email system without prior notice (3rd time now during the past few years). Spam issues are giving the mail system a hard time. The new system is much better (filtering and junk mail handling), but it does not provide mailing list facilities anymore. Even worse, the members of the QL News list seem to be lost - I asked them twice for the list, but it was stored in their old email system. They have not provided me with a list so far, and I doubt it will happen.*

*I will mail important updates and news to QL Users now.*

*The SMSQ homepage will also inform about upcoming QL meetings and updates."*

To subscribe to the QL-users email list you should email:

**QL-users-q-v-d.com-request@lists.q-v-d.com**

with the word **"subscribe"** in the body of the text.

## STIQQIES

Stiqqies is a new freeware program from **Dilwyn Jones**. Dilwyn writes:

*"Basically, it provides an electronic version of those sticky little coloured paper notes you affix to your desktop to remind you of things! (Am I allowed to compare it to Post-Its?)*

Take advantage of your SMSQ/E system's high resolution screen (and high colour if you have it) to pin little messages to your screen. The program needs Window Manager 2, which means QDOS with pointer environment version 2 or SMSQ/E version 3 or later. It's free, easy to use and available now. It may be downloaded from:

[www.dilwyn.uk6.net/misc/index.html](http://www.dilwyn.uk6.net/misc/index.html)

- Windows
- Blue Green & Yellow
- Soothing Grey
- Nice Brown/Yellow
- Traditional Paper

A seventh option allows you to choose your own colours. Duncan's patch can be downloaded from Dilwyn Jones' website:

[www.dilwyn.uk6.net/gd2/index.html](http://www.dilwyn.uk6.net/gd2/index.html)

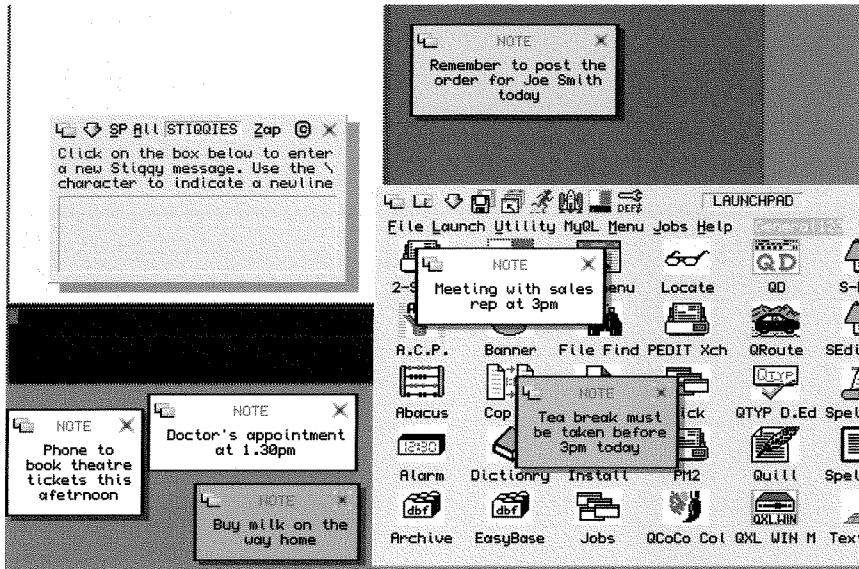

## VISTA Compatibility

Dave Walker has reported a compatibility problem with QPC2 and Microsoft's new Vista operating system. For the technically minded he received the following message:

*"The ordinal 1100 could not be located in the dynamic link library WSOCK32.dll"*

Quick as a flash Marcel identified the problem as being the removal of the `inet_network()` function from Vista.

This only effects versions of QPC2 from 3.30 when the

TCP/IP support was implemented. Marcel promises a new version of QPC2 will be issued in time.

## Rainbow Texting

Recently QL word processing has become more colourful. Early last year **Roger Godley** gave us a GD2 version of Quill and late in the year Duncan Neithercut a multicoloured version of Text87.

In his own words:

*"Ever get bored looking at the plain old black paper white text version of Text87. I did as I mainly use a Q60 which does not have an alternative colour scheme after patching with Marcel Kilgus Text87plus4 patch program. Hence this program which can patch 6 different schemes into Text87plus4 and also has a crude colour editor allowing even more esoteric colour schemes to be created."*

In practice Duncan's program is a patch of a patch and is thus not for every Text87 user. You must use a copy of Text87 that has been patched with Marcel Kilgus' Text87 patch program, and for this program you have to have either version E4 of Text87 (116850 bytes) or version G4 (117354 bytes). You also have to patch in the old colours of red, green and black.

Duncan's program is written in SuperBasic and you have to modify the code to give the file-name of your copy of Text87plus4.

The program has 6 colour options:

- Pretty in Pink

## QL Subversion

Many years ago, after attending a week's work training, QL Today's editor was assessed by his tutor, "Your hallmark on this course has been constructive subversion". He is thus unable to complain about the theme of Dilwyn Jones' 2007 QL calendar.

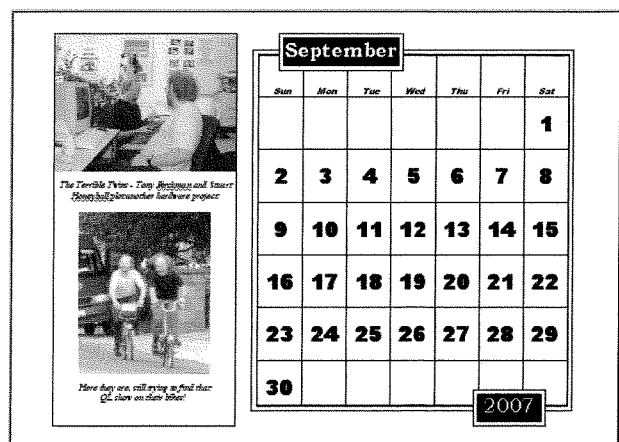

Dilwyn writes:

*"With the end of the year fast approaching, I decided (with some nudging by people like Geoff*

Wicks) that it was high time I released Qalendar 2007.

This one has a rather more subversive theme to it than previous years - to see what I mean you'll have to download it and look at the pictures. No mean task - unless you're on broadband - it's 2.7MB long, in M\$ Word format and will take several minutes to download on dial-up. Plenty of pictures of certain well known QLers in photos they'd perhaps rather I didn't print?

What the hell, give it a go and download it from: [www.dilwyn.uk6.net/gen/calendar/calendar.html](http://www.dilwyn.uk6.net/gen/calendar/calendar.html)

There are also several QL based programs for time and date handling, such as my own Multi-Cal program (written in SuperBasic, so you study the code and adapt it to your own requirements), on my Utility Software download page at

[www.dilwyn.uk6.net/utills/index.html](http://www.dilwyn.uk6.net/utills/index.html)

(Since we received our main report on the 2007 QL calendar, we have heard that it can also be downloaded as a PDF file of just over 600Kb. Thanks to Derek Stewart for this conversion.)

As an added bonus you can try to spot which of the photos in the calendar came from QL Today. (OK, you've guessed one of them already. It is the photo showing all the Quanta officers in a compromising situation. Touché, Mrs. Gilpin, you should not have made the editor wear that T-shirt.)

## QUANTA goes Electronic

Quanta shortly hopes to fulfil a long-standing ambition by offering its members the option to download the Quanta Magazine instead of receiving it by post. If all goes well this will start with a new volume of the magazine in February/March 2007.

Quanta started experiments to produce the magazine in electronic form just over a year ago and our illustration shows one of the early examples. Circulation was to Quanta committee members and a small group of testers. The greatest stumbling block to an electronic magazine has been the file size, which had to be kept low for members without broadband.

Late last year Quanta secretary, Sarah Gilpin, informed traders:

"In order that this can be achieved the file size of the completed magazine has had to be reduced to approximately 500Kb, to enable those without broadband facilities to receive this publication."

Sarah Gilpin then announced changes to the magazine's advertising policy:

"The committee is aware that all traders have supported QUANTA for many years by advertising in QUANTA Magazine and that the costs incurred have not been recovered for some time by their trading profits. All the current traders adverts are in photographic format files, which are of considerable size compared with the text content of the magazine. In electronic format it is suggested therefore that the traders adverts would no longer be shown on their individual pages, but instead a single page containing suitable text and hyperlinks to the advertising section of the new QUANTA Web site where trader's adverts will be shown in full and further hyperlinks to their individual web sites as requested.

It is suggested by committee that these changes would result in there being no annual fee for advertising, but the traders would be expected to become full QUANTA members."

Traders reacted coolly to this announcement, mainly because Quanta had failed to consult them beforehand, and had omitted to send them a sample copy of the electronic magazine. All three traders who reacted to Quanta's announcement asked to be sent a sample copy.

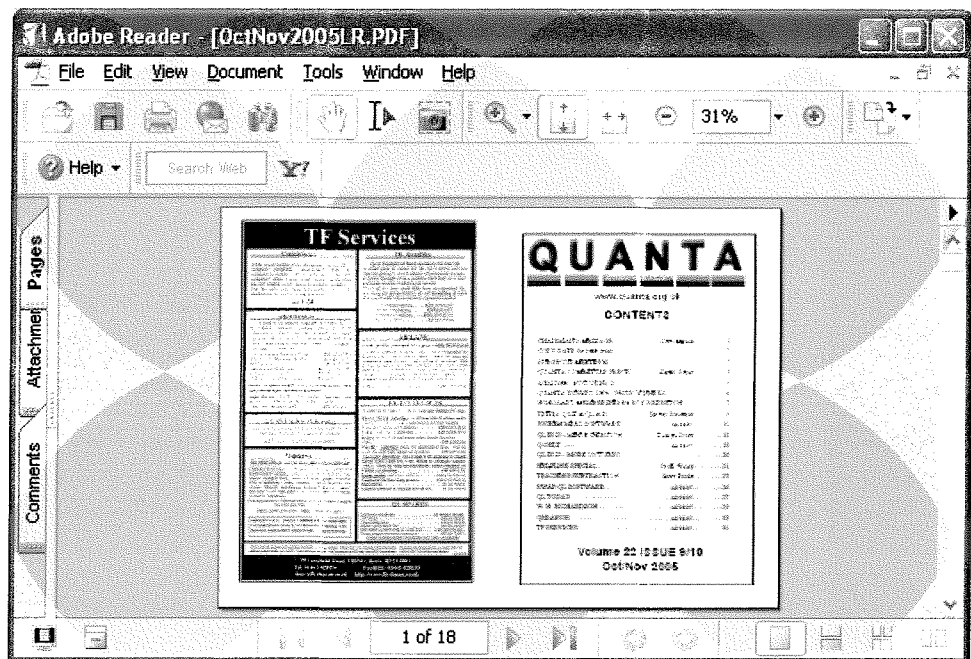

One trader commented:

"I think that you are making a basic error here. I can understand that the size of the files used in the adverts would make electronic download prohibitive for people without a broadband but by this you are saying to us that our advertising would not reach anyone without broadband because they would still have to download those files in order to see the ads."

## QL Today Distribution

Recently there have been queries about why some readers receive their copy of QL Today long before others.

QL Today is split between two countries, the UK and Germany. Production is done in Germany and copies to continental subscribers are posted to them from Germany and the Netherlands. Where possible the magazine is published to coincide with shows so that the UK and most of the USA copies can be handed over directly. If this is not possible they have to be sent to the UK by courier. They then have to be put in envelopes, labelled and stamped. This process can take between 2 days and a week.

UK readers report that they receive the magazine on different days, but this is caused by the relative efficiency of the local postal service. All UK copies are posted from the same post office on the same day.

During the last renewal some UK subscribers expressed surprise that, given the fall in the number of QL-ers, we were still able to publish the magazine. In practice our circulation remains healthy and our readers loyal. Last year the number of readers not renewing their subscription remained well below double figures.

Our major concern at the moment is rapidly rising distribution costs. Last summer the UK postal services increased the postage for "large" items, which includes the QL Today A4 mailings. This year the German post office has ended their world economy service so that USA copies of QL Today now have to be sent by much more expensive airmail. At the same time they have increased upper weight limit of the price category in which QL Today falls from 250g to 500g with a consequent increase in price. The alternative Dutch postal service has increased its tariffs by over 5%, and removed economy services as well.

Increased costs have not given us a more efficient service. Jochen posted a letter by airmail to the editor on 12th December. It arrived on the 4th January.

Finally, the QL Today team would like to thank all readers who expressed their appreciation of the cover disk included with the last issue. We have plans for another cover disk later in this volume.



**JUST WORDS!**

# NOW ALL FREE!

---

*Just Words! has now made all its programs freeware. That means that you can download and copy them freely, although the copyright remains with the author. What you are not allowed to do is resell them, or modify them in any way.*

*If you are unable to download from our website, then you will still be able to buy the programs at QL shows for a nominal fee to cover costs.*

*Also on our website is a comprehensive range of QTYD dictionaries in several languages, a handy help and advice section and the latest QL shows information.*

---

**Geoff Wicks, 5b Wordsworth Avenue, Sinfin, Derby, DE24 9HQ, U.K.**

**Tel: +44 (0)1332 - 271366**

**email: [gwicks@beeb.net](mailto:gwicks@beeb.net)**

**Web: <http://members.lycos.co.uk/geoffwicks/justwords.htm>**

---

# Gee Graphics! (on the QL ?)

## - part 47

by H. L. Schaaf

### Thanks again.

Thanks to Steve Poole. I had a welcome note on October 29th from Steve with a response to my plea for a more elegant way to program the Goduko/Sudoku solver in GG#46, QL Today July/August 2006, Volume 11, Issue 1, page 8. Steve explained that by converting certain

PROCedures to FuNctions (with RETurns) and then having a NEXT sweep we can eliminate the GOTO that was on line 4040. Merge the listing below into the sdk3c3k5\_bas program from GG#46 and enjoy a program without that awkward GOTO.

```
100 REMark sdk3c3k6_bas
110 REMark H. L. Schaaf & Steve Poole
120 REMark July 12 & December 17, 2006
130 REMark for GG#46 & 47 QL Today
600 IF Doub: NEXT sweep
2090 LOCAL i, j, p
2150     p = place (i,j,(opt$(i,j)),4)
2250 DEFine FuNction Doub
2260 LOCAL i, j, p
2490 IF NOT(found2) : i = trip
2650 p = place (row,col,choice1$,2)
2670 p = place (row,col,choice3$,7)
2685 RETURN 2
2690 END DEFine : REMark Doub
2720 DEFine FuNction trip
2940 IF NOT(found3): PRINT#0;'no triples ?' : pause 300 : i = unwind
2945 RETURN 3
2950 END DEFine : REMark trip
2980 DEFine FuNction place(row,col,plc$,nk)
3380 nest = unwind
3555 RETURN 1
3560 END DEFine : REMark place
3580 DEFine FuNction unwind
3980 p = place (g_row,g_col,choice2$,242)
4030 :
4040 RETURN 1
4050 END DEFine : REMark unwind
7750 REMark end of listing sdk3c3k6_bas
```

### Thanks to Marcel Kilgus.

In an exchange between Steve and Marcel, the control over the graphic aspect ratio was revealed in QL Today November/December 2005, Volume 10, issue 3, page 47 Marcel shows us what and where to POKE, at least for QPC. Per Witte raised the question again in the QL-User newsgroup and on October 5 Marcel shed more light, naming the variable as pt\_asprt located in the CON driver linkage of more recent versions of SMSQ/E.

I had wrestled with the aspect ratio in GG#3, QL Today March/April 2006, Volume 2, issue 6, page 46. The program "Graspix\_bas" listing was not

printed with the article but was zipped onto the QL Today Cover Disk 2 for Volume 2. Unzip the LISTINGS\_E\_ZIP and look for Graspix\_bas. Read the GG#3 article and try the program on your setup. I altered that Graspix listing to accommodate SMSQ/E later than version 2.89 in GG#25, QL Today November/December 2001, Volume 6, issue 4, page 15.

And here we go again, GG#3, GG#25, GG#47; will we return to this in GG#69?

Marcel has added PEEK\_F and POKE\_F in QPC II v 3.33, and if you have that you might enjoy trying pt\_asprt\_bas.



The idea is to draw circles, then actually measure the vertical and horizontal dimensions as displayed on your screen. Using their ratio we adjust the pt\_asprt variable and try again. This should lead to a more nearly 'perfect circle' on your screen. We can probably extend the idea to auto-scaling of the horizontal axis for charts, graphs, etc. As Marcel points out, the ratio you get on your printer may differ from that on your

screen, but we can make the measurements on the printout, then reset pt\_asprt for printout purposes. Measuring in millimeters seems close enough for me. This lets us make adjustments in software instead of tweaking the horizontal size adjustment of the monitor. As another check the diagonals will meet at right angles when the 'perfect circle' is found.

```

100 REMark pt_asprt_bas
110 REMark HL Schaaf December 16, 2006
120 REMark for QL Today GG#47
130 :
140 REMark see QL Today V.10, N.3, p.47
150 REMark needs QPC version 3.33
160 REMark changes pixel aspect ratio
170 REMark uses new POKE_F, PEEK_F !!!
180 :
190 REPEAT muck_about
200   find_pt_asprt
210   SCALE 100,0,0 :CLS
220   LINE 50,0 TO 50,100
230   LINE 0,50 TO 100,50
240   LINE 0,0 TO 100,100
250   LINE 0,100 TO 100,0
260   LINE 100,0 TO 100,100
270   FOR i = 10 TO 50 STEP 10
280     CIRCLE 50,50,i
290   END FOR i
300   INPUT#0; 'circle width  ? ';hs
310   INPUT#0; 'circle height ? ';vs
320   PRINT\\ 'h/v = ';hs/vs
330   PRINT 'v/h = ';vs/hs
340   INPUT #0; 'Desired ratio as H/v or V/h ? ';vorh$
350   INPUT#0; 'desired ratio ? ';dr
360   IF vorh$=='v' : d_asprt = dr
370   IF vorh$=='h' : d_asprt = 1/dr
380   PRINT 'new v/h to be ';dr
390   PRINT 'new h/v to be ';1/dr
400   new_asprt = pt_asprt_val*(vs/hs)/d_asprt
410   PRINT 'pt_asprt was ';pt_asprt_val
420   PRINT 'new pt_asprt to be ';new_asprt
430   POKE_F(con_base+$14A),new_asprt
440   PRINT 'now pt_asprt is ';
445   PRINT PEEK_F(con_base+$14A)
450 END REPEAT muck_about
460 :
470 DEFINE PROCEDURE find_pt_asprt
480   con_base = PEEK_L(!;$C4)
490   PRINT #0;'console base is at ';con_base
500   pt_asprt_val = PEEK_F(con_base+$14A)
510   PRINT #0;'aspect ratio is ';pt_asprt_val
520 END DEFINE find_pt_asprt
530 :
540 REMark end listing aspect_ratio_bas

```

## Thanks to Alf Kendall

After the Niagara Falls QL event Alf e-mailed me his boot program. It auto-magically maximizes the

screen usage for QPC. I hope he will share it with others, maybe as an article for QL Today?

# CALLing Machine Code

by George Gwilt

Many programs written in S\*BASIC rely on calling machine code for part of their operation. Such programs have to arrange to load the code into space allocated from the heap. It is always a nuisance if the code has to be loaded from a file. The user must ensure that the file is in the directory expected by the program. This might mean having to load the correct floppy disk, or it might mean typing in the directory's name on a request. How much better to have the code somehow inside the S\*BASIC program itself.

I have written so many programs of this type that I have, now, an easy method of incorporating machine code. The method involves calling a procedure and merging the resultant file with the S\*BASIC program. The procedure is called Set\_Hex and it takes three parameters. The first is the filename of the code to be included, the second is the filename of the output file to be merged and the third is the first line number to be used.

## What Set\_Hex Does

The parameters are a\$, b\$ and line%. Set\_Hex does the following five things.

1. Tests that the first parameter, a\$, is a file which can be opened.
2. Opens the second parameter, b\$, if possible, after deletion if necessary.
3. Prints 16 instruction lines to line% with increments of 10.
4. Prints a DATA line with the file length of a\$
5. Prints successive DATA lines, at intervals of 1, with up to eight integers taken from the input file a\$.

## What the Output File Does

The output file is a S\*BASIC program which contains a function called Load\_Hex which allocates space from the heap and loads into it the information from the DATA lines at the end of the program. It then returns the address of the allocated area or -1 if something has gone wrong..

## Example

As an example, the output file from an application of Set\_Hex is shown at the end. The first file presented to Set\_Hex contained the instructions:

```
MOVEQ    #0,D0
RTS
```

These assemble to:

```
$7000 or 28672
$4E75 or 20085
```

These integers, as you can see, are the contents of the second DATA line in the output file. At the very end are the S\*BASIC instructions to use the output file.

## Comments

1. The program Set\_Hex was written for use with S\*BASIC programs which would be compiled by Turbo. It includes the Turbo TK keywords:

```
DEVICE_STATUS
INPUT$
GET%
ALLOCATION
DEALLOCATE
```

Thus, to be RUN it needs Turbo TK to be loaded. It is of course open to anyone who wants to use it to alter the program to include TK2 keywords instead.

2. The function Load\_Hex in the output file makes some checks. If these fail it returns -1 instead of the address of an allocated area.

The first DATA item is the length in bytes of the code to be loaded. This must be positive. Unless the user has altered that DATA line this error cannot occur.

The allocation of space must succeed, else we are out of space.

The most important check, which again will not fail unless the user has tampered with the DATA lines, occurs at every instance of POKE. No POKE is allowed to be implemented if it would write to a location over the top of the allocated area.

Load\_Hex will stop with an error if there are not enough DATA items. This error is not trapped., but again will not occur unless the DATA lines have been corrupted.

## Program Set\_Hex

```
100 DEFine PROCedure Set_Hex(a$,d$,line1%)
110 REMark to set the HEX from a$ to b$
120 LOCAL l,ct%,b$(2),c$(6),wd%,xx,m%,line%,in%,out%
130 IF a$="" OR d$="":RETURN
140 IF DEVICE_STATUS(1,a$)<0:PRINT#0, "Can't open "&a$:STOP
145 in%=3:out%=4
150 OPEN_IN#in%,a$
160 l=DEVICE_STATUS(2,d$):l=(l=-8)+(1<0)*2+(1>0)*4
170 SElect ON l
180 =3:DELETE d$
190 =4:REMark OK
200 =REMAINDER : PRINT#0,"Can't open "&d$:CLOSE#in%:DELETE b$:STOP
210 END SElect
220 OPEN_NEW#out%,d$
225 line%=line1%+160
230 Set_Ld
240 l=FLEN(#in%)
245 PRINT#out%,line%&" DATA "&l
250 m%=1-2*INT(1/2)
260 l=INT(1/2):ct%=0:b$="," :line%=line%+1:c$=" DATA "
270 FOR xx =1 TO l:wd%=GET%(#in%):input
280 IF m%:wd%=CODE(INPUT$(#in%,1)):input
290 IF ct%:PRINT#out%,CHR$(10);
300 CLOSE#in%:CLOSE#out%
310 END DEFine
320 :
330 DEFine PROCedure input
340 LOCAL a$(100)
350 IF ct%:a$=b$:ELSE a$=line%&c$:line%=line%+1
360 a$=a$&wd%:ct%=ct%+1
370 IF ct%=8:a$=a$&CHR$(10):ct%=0
380 PRINT#out%,a$;
390 END DEFine
400 :
410 DEFine PROCedure Set_Ld
420 LOCAL a$(150),lp,ll%,y
430 ll%=line1%:RESTORE 500
440 REPeat lp
450 READ a$:IF a$="":EXIT lp
455 y="line%" INSTR a$
457 IF y:a$=a$(1 TO y-1)&line%&a$(y+5 TO LEN(a$))
460 PRINT #out%,ll%&" "&a$
470 ll%=ll%+10
480 END REPeat lp
485 END DEFine
490 :
500 DATA "DEFine FuNction Load_Hex"
510 DATA " REMark This returns the address of an"
520 DATA " REMark Allocated area containing the HEX"
530 DATA " REMark DATA at line line%"
540 DATA " REMark If a mistake occurs -1 is returned"
550 DATA " LOCAL m,asad,adr,top,x,k,wd%"
560 DATA " RESTORE line%:READ top"
570 DATA " IF top<=0:RETURN -1"
580 DATA " asad=ALLOCATION(top)"
590 DATA " IF asad<0:RETURN -1"
600 DATA " k=INT(top/2):adr=asad"
610 DATA " m=top-2*k:top=asad+top"
620 DATA " FOR x=1 TO k:READ wd%:IF adr+2>top:DEALLOCATE asad:RETURN -1:ELSE:POKE_W
    adr,wd%:adr=adr+2"
630 DATA " IF m:READ wd%:IF adr+1>top:DEALLOCATE asad:RETURN -1:ELSE:POKE adr,wd%"
640 DATA " RETURN asad"
650 DATA "END DEFine", ""
```

## Output File from Set\_Hex

```
2000 DEFine FuNction Load_Hex
2010 REMark This returns the address of an
2020 REMark Allocated area containing the HEX
2030 REMark DATA at line 2160
2040 REMark If a mistake occurs -1 is returned
2050 LOCAL m,asad,adr,top,x,k,wd%
2060 RESTORE 2160:READ top
2070 IF top<=0:RETURN -1
2080 asad=ALLOCATION(top)
2090 IF asad<0:RETURN -1
2100 k=INT(top/2):adr=asad
2110 m=top-2*k:top=asad+top
2120 FOR x=1 TO k:READ wd%:IF adr+2>top:DEALLOCATE asad:RETURN -1:ELSE:POKE_W adr,wd%:
    adr=adr+2
2130 IF m:READ wd%:IF adr+1>top:DEALLOCATE asad:RETURN -1:ELSE:POKE adr,wd%
2140 RETURN asad
2150 END DEFine
2160 DATA 4
2161 DATA 28672,20085
```

## Program to Use the Above

```
1000 call_address = Load_Hex
1010 IF call_address>0: CALL call_address: REMark this does nothing!
1020 STOP
```

# GPS and QPC – Part 2

by Hugh Rooms

## Hardware

This is a chronological story of what I did so I start with PICs from Microchip (complete computers - well without unnecessary things like keyboards and displays - on a single integrated circuit) which I have used for some years: I have built a couple of programming boards from *Everyday Practical Electronics* magazine (EPE)(12). I am grateful to this excellent magazine for many of the ideas I have used. One of the boards, 'Icebreaker' (EPE March 2000) has an interface to a PC (not the interface I added later to transfer data to QPC) so that you can single-step, examine registers, and all sorts, making writing your PIC program much easier and more effective. Among other peripherals it has an LCD, and a small breadboard area. And it has a convenient 5v supply available, with plenty of oomph to drive extra circuitry.

In January 2004, EPE had described interfaces, to a PIC and a PC, for a commercial GPS handheld receiver, too expensive for me. Then, in EPE January 2005 there was a 'Speed Cameras Watch' system for warning car drivers, based on GPS positioning and a data base of camera locations. Although I was not really interested in that particular project the receiver it specified (3), from Holux, was just what I wanted, so I bought

one. I used the program from the 2004 article, modified to suit, in Icebreaker to display the output from the receiver on its LCD. However, as I said earlier, by carelessness with the leads I blew that receiver up: I connected the supply voltage to an output pin. If I hadn't destroyed it, the same interface that I describe here would have been applicable, but much simpler, the Holux receiver has wires rather than a ribbon cable and the PPS and ALMRDY outputs do not apply.

Later in 2005 I heard of a receiver by RF Solutions. GPSM001 (2), that suited me even better than the Holux module, as it had a 'Pulse Per Second' output (PPS) that I hoped to use in timing circuits, such as a frequency counter, although that project remains a long way off. I bought one of those, and determined to take much greater care this time.

The biggest disadvantage of this GPS module, for me, was the close pitch of the 16 individual connections in its 8mm wide ribbon cable interface. RF solutions provided a socket for the cable, but I dithered for months, considering various ideas, before attempting to make a p.c.b. to connect it to something more easily handled, but eventually I succeeded on the second attempt. The mm scale in figure 2 shows the fineness of



## Independent QL Users Group

World-wide Membership is by subscription only,

Offering the following benefits:

Bimonthly Newsletter – up to 40 pages

Massive Software Library – All Free!

Free Helpline and Workshops

Regional Sub-Groups. One near you?

Advice on Software and Hardware problems

Subscription just £14 for UK members

Overseas subscription £17

Barclaycard: Visa: Access: MasterCard: Accepted

**\*Now in our Twenty Third Year\***

Further details from the Membership Secretary

**John Gilpin, 181, Urmston Lane  
Stretford, Manchester, M32 9EH (UK).**

**Tel. +44 (0) 161 865 2872**

**Or**

**Visit the Quanta Web Site**

***<http://www.quanta.org.uk>***

***E-mail: [membership@quanta.org.uk](mailto:membership@quanta.org.uk)***

### **Next QUANTA Sponsored Event Sussex QL User Group**

**Present:**

### **The HOVE QUANTA AGM & Workshop**

**At Portslade Town Hall**

**Victoria Road,**

**Portslade,**

**Sussex. BN41 1YF**

**On**

**Sunday 15<sup>th</sup> April 2007 10am till 4pm**

**Watch later QUANTA and QL Today Magazines for full details.**

the lines needed. These were the first p.c.b.s I had ever etched, but, untidy as it is, it works: it's also visible in the photo of the board I took to Hove. It all had to be done using a watchmaker's eyeglass - working a couple of inches from the board, the biggest danger was poking myself in the nose with the soldering iron. In the end I had a connection from the module's 16 pins to a 15-way D type plug; pin 15 of the GPS module is not used, so I left that one out. Now I have more experience I would only connect the few pins I use, that might make it easier next time.

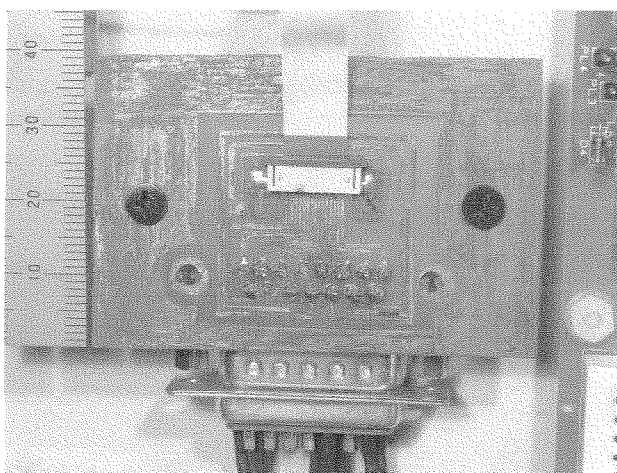

Figure 2

## GPSM001 outputs and inputs

I'll deal with the circuit, figure 3, later on, but you might find it useful to refer to it now.

The GPS module requires a 3.3V power supply at pin 3 of its interface, and an antenna which contains an rf. amplifier supplied with d.c. power through its co-axial cable.

Of the fifteen pins, I used only seven. Several of the others need to be set to ground or to the 3.3v Vcc, but they have internal 'weak pull-ups', which means that they are connected internally via a resistor to the 3.3v, so that they can be left as they are for the default ("high"), or connected directly to ground to change the setting to "low", when the internal resistor limits the current flow from 3.3v to ground to a very low level. I was able to leave these alone except for the baud rate, pin 4. The default baud rate is 9600. Tying pin 4 to ground changes this to 4800, expected by the program I intended to use.

Pin 2 switches the module off if tied to ground: I found that gunge left over from my soldering was enough of a 'tie to ground', by connecting the adjacent 2 "OFF" and 1 "GND" tracks on my little p.c.b., to keep it all turned off until I cleaned up.

Data from the GPSM001 is sent as binary ASCII codes from TXA, pin 7, in binary form, zero volts is a 'zero' bit and 3.3V is a 'one'.

To understand the ALMRDY output of this device, we need to look into the way it works. To calculate its position, when in use and working happily, the GPSM001 needs several sets of data, which are stored in its non-volatile memory when it is switched off. One requirement is the stored datum for the mathematical model of the earth's surface, the standard and default being WGS84, this is valid for years unless you change to a different ellipsoid model, and is built in by the manufacturer. Second is the 'almanac', which is generally valid for some months. Third is the 'ephemeris' which changes hour by hour. As I said earlier, both the latter may have to be downloaded from the satellites themselves before a fix can be attempted, unless the switch on is very soon after the previous 'off', and the data is still valid; and they are then kept updated while the unit is on. One output from the GPSM001, on pin 11, is 'ALMRDY', which goes high when either the stored almanac is confirmed as valid, or a new, current one, has been received. Correct ephemeris received is, I assume, signalled by the "Status" field in the \$GPRMC line of the output data changing from "V=void" to "A=active". Among the other data, the current position is also stored, and used as a starting point for checks when it is switched on again. After several months 'off' it took nearly an hour after I first switched on before it gave a valid position, although some of that may have been due to my ignorance, - I may have accidentally kept it turned off with pin 2, the on/off command pin without realising it, as I mentioned.

The device has an on-board clock, which starts up as soon as power is supplied and is synchronised with UTC when a valid signal is received. At pin 8, PPS, normally low, a 'pulse per second' is output, which is correct to within 0.4 milliseconds (mS) of UTC at the rise of an 83mS long pulse.

The other inputs and outputs are to do with power saving, back up power supply, and customer modification of the default operation. I have not investigated any of these.

## Construction

My first success was to have the results displayed on the Icebreaker LCD, with the interface to GPSM001, which I'll describe soon on its breadboard, and the different items lying around on the bench. A 12V d.c. supply plugs in at the top of the Icebreaker.

On the Icebreaker bread board I also rigged up LEDs to display ALMRDY and PPS; with latitude, longitude, date and time on the LCD, using a modified EPE program in the PIC.

To be able to carry the set-up around, I screwed the various parts to a board, figure 1, demonstrated at Hove. **(Figure 1 is the Cover - Ed.)** The Icebreaker p.c.b. is across the top, the PIC is the large black I.C. on it. The GPSM001 is the silvery object at the left, lower down. On its right is the small p.c.b. with the interface to the ribbon cable, and a D type plug with wires to the rest of the circuit. Below the GPSM001 is a socket with the lead from the antenna. Later on I added, at the right at the bottom, a second breadboard with the RS232 driver for the PC interface, and above that the D type socket for the connection to QPC. At the top of the board is the Icebreaker's own D type socket, which I did not use after downloading the program to the PIC.

### Operational amplifiers

The circuit I use is based on operational amplifiers (op-amps). If you are familiar with op-amps then the next couple of paragraphs will be old hat, but I am told that the main complaint about QL Today articles is that they are too technical, so I am trying to write this for those unfamiliar with electronics, as well.

Operational amplifiers were originally developed as central parts of analogue computers used to solve mathematical problems before digital computers became the norm. Built from valves they were big and power hungry. They were drawn in diagrams as the sideways triangle you see on my circuit, and that convention persists even though the mathematical use is now a very minor one. In the 1960s the first operational amplifiers on an integrated circuit chip were invented, one of the originals, the 741, is still popular and was closely followed by a variety to suit every purpose. Basically they are very high gain d.c. ampli-

fiers, requiring virtually no current into their inputs, and capable of giving a reasonably high current at their output. If the two inputs are kept at the same voltage, then the output is zero. A very small difference in the inputs causes a large voltage swing at the output. The inputs are labelled '-' and '+', or 'inverting' and 'non-inverting' respectively: if the '-' input is regarded as the zero reference, then a small increase in the '+' input voltage cause a positive swing in output, and conversely, regarding '+' as zero reference then a small positive voltage on the '-' input causes the output to go negative, i.e. inverted. The 741 requires positive and negative supply voltages to give an output swing above and below zero.

This very simple model is not realised in practice: a slightly non-zero difference in inputs is needed to give a zero output, and often connections are provided to nullify this offset, and other slight problems, externally. In the present application this doesn't matter as the input swing is wide enough to swamp any of these effects. I am not describing here the circuitry to use them as linear amplifiers, that's in all the books.

The LM358 that I use is a useful general purpose, cheap, chip: two op-amps in an 8 pin package as shown on the circuit diagram, with an output swing between just above zero to about 1.5V below the single-sided supply. The internal connections are shown on the circuit diagram. I used two, I could probably have used a 'quad' version but the 358s were already in my "come in handy" stock.

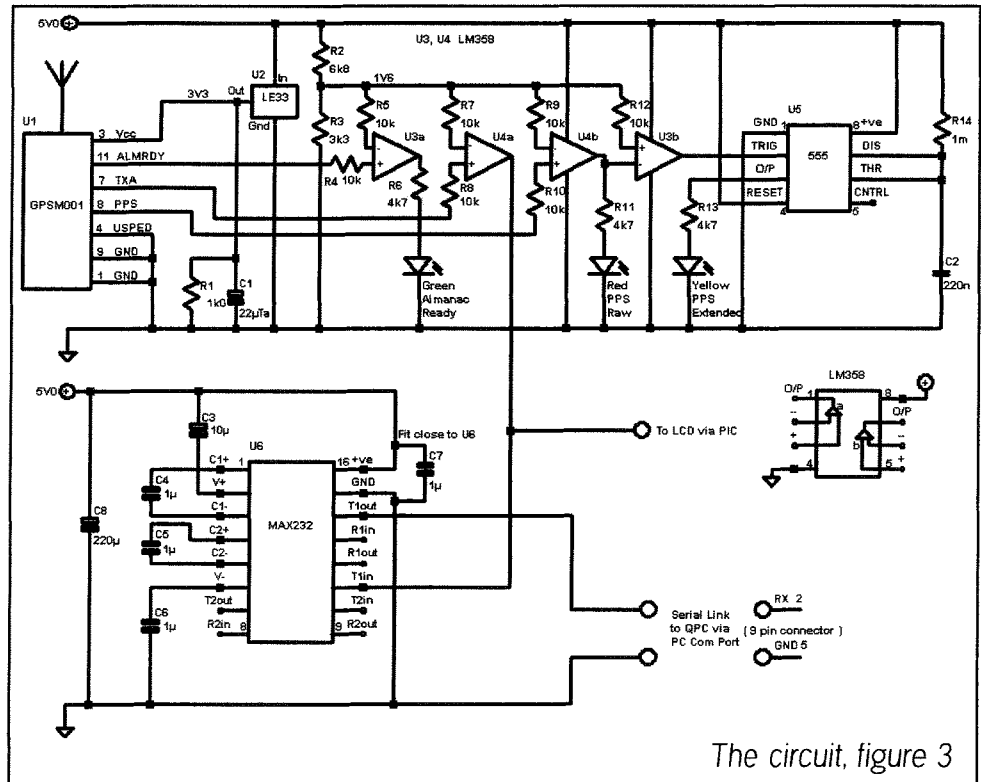

The circuit, figure 3

If you're not already familiar with the notation for resistor values, such as 4k7, here is an explanation. A decimal point can easily be overlooked in a circuit diagram, or a spot can be mistakenly read as one, so it is common now to use the multiplier, k (kilo) or m (mega) in place of the decimal point, so 4k7 is 'four point 7 kilohms'. For resistors under 1k0, R is used for the point, so that '220 ohms' is 220R and 'four point 7 ohms' is 4R7. To avoid confusion with R1, meaning 'resistor number one', 0R1 is used for '0.1 ohm'. I use a similar idea for voltages.

The Icebreaker provides a smooth 5V supply which can be used directly for most of the components, but the GPS module requires a 3.3V supply, provided by the LE33 Voltage Regulator. Tantalum capacitor C1 is recommended in the data sheet, and I added R1 to load and test the output before I connected the GPS, so it could be removed now (but CBB and IWSWFI). Two GPSM001 pins are 'GND' and the data sheet gives no special instructions, so they are both tied to zero volts.

I will mention here something that I discovered much later: the ribbon cable fits into a socket in the receiver, and unwittingly I had loosened this, and the cable twisted sideways, shorting the power line to ground. It was a good test of the thermal limiting of the regulators, the GPSM001 should draw 30ish mA, it was 300odd mA when I measured it. Alerted by the hot smell from the Icebreaker's voltage regulator, it was a fright until I found the cause and put it right. A relief to find the receiver had survived it all and worked again. The only input from this circuit to GPSM001 is at pin 4, USPED. Left open this makes the output baud rate 9600. By tying it to ground I get 4800 to match the program in the PIC. I could have changed the programs to all work at 9600 baud, but I was keen to see if it worked, so CBB.

The outputs of the GPSM001 swing from near zero to near 3.3V. To protect them I use the op-amps as buffers, so that the current drawn from the GPSM001 is negligible, nano-amps, and the op-amps supply the currents, a few milli-amps, to drive the LEDs.

***(Please note that Hugh Rooms has informed us of an error in figure 3. The LED current limiting resistors are given as 4k7; they should all be 470R. Hugh offers his apologies. Ed.)***

All in my circuit except the GPSM001 uses 5V logic. So, rather than investigating and using a possible 3.3V approach (CBB), the op-amps are wired as comparators to convert the 3.3V levels

from the GPS module nearer to 5V to suit the PIC and other devices. R2 and R3 form a potential divider across the 5V supply, so their junction is at about 1.6V, and is applied to one '-' input of each of three op-amps. The outputs of the GPSM001 applied to the '+' input swing above and below this, so the outputs of the op-amps do the same. (U3b is different -- I'll come to that.) Maximum allowed output current is about 40 mA, plenty to drive an LED. I am obsessed with avoiding damage to the GPS module, so, to this end I have put 10K resistors in all the low current leads, for further protection if a high voltage gets accidentally applied. A lot of these could be left out, I suppose, but IWSWFI rules yet again.

The simplest output is ALMRDY which turns on the green LED. All LEDs are fed via a 470R resistor which, with the voltage drop across the LED allowed for, gives about 3.3 mA.

When I first tried to see the PPS, via U4b, the brief flash was almost invisible, so I added the 555 timer to extend the pulse to about a quarter of a second, using a monostable circuit straight out of the book, with duration set by R14 and C2. I couldn't find a 555 monostable circuit triggered by a rising edge, so I used U3b as an inverter by reversing its inputs. Since the pulse from GPM001 is so short it would not really matter here if the 555 was triggered by its falling edge, but I had an op-amp spare for it.

After admiring the display of my home latitude and longitude on the Icebreaker LCD for a while, I looked for even more excitement, and found it in the movement of the satellites in their orbits across the sky. Among the data sent out of the GPSM001 each second are the bearing and elevation of the satellites in view. Plotting these on a PC screen should show their movement nicely. It did - see figures 5, 6, 7, and 8 (***please see QL Today Vol. 11 Issue 2 pages 41ff***). This is what I showed at Hove.

To do this needed an input to the PC, and EPE of January 2004 described an interface. In fact it is again a 'straight off the data sheet' use of a Maxim MAX232 chip, which does the conversion between 5V logic levels and the plus and minus 12 or 15 volts of the RS232 standard used by a PC's serial COM ports. I mounted it on the second small breadboard. In my diagram, C3, C4, C5, C6, and C7 are as recommended in the data sheet for the MAX2332. I only use one of the four channels provided, namely T1 to transmit data to the PC. C8 is a precaution as the 5V power lead to the board is getting a bit long.



# Start Here - Part 7

## Essential Information For 21st Century QLers

by Roy Wood

### Getting Your Back Up

It is familiar territory to anyone who uses a computer. Sitting there staring at a blank screen which should be showing you the desktop you lovingly created to give you access to your programs and, more importantly, data. At this point the least together members of the community start to wrench out whole swathes of hair, bang their heads on the table and bash bits of the computer in the vain hope that the data will fall from a hitherto unknown place and the thing will spring to life again.

The more adjusted and aware people will smugly reach for their backups and then realise that they have not done any for two months and that long article for QL Today, all their tax accounts and the whole of their address book is hopelessly out of date. At this point you, of course, revert to that little branch of life's program which is GOTO 'least together' and tonsorial ripping commences.

Taking backups is a chore. It is time consuming and it is something you always put off till tomorrow - or maybe the next day or even the day after the hard drive fails to make its usual chugging noise. There is no point in being smug about backups. They are vital if you use a computer for anything at all and they are worthy of some serious thought.

### Why do it?

Well, there are many reasons for making backups apart from the obvious worries about data loss. You may, for instance, have two computers both running the same programs. Easy enough to keep the programs the same but not so simple to make sure that the copy if the long letter to the insurance company about the accident is not more recent on the one you are overwriting than the one you backed it up from.

You may also want to reformat the drives and change the way the structure of the system looks. Add a bigger main drive etc. A Backup Utility is a vital tool for doing this. It is also possible that a program you have installed or changes you have made to the configuration and BOOT file crashes the system at startup and you want to go back to how it was before. Not such a problem with QL systems I realise but let us make

this a more general discussion of the problems involved. The PC suffers from this more than any other system because one wrong decision and the whole thing is unrecoverable without a long struggle or some expert knowledge. When you look at systems people have in their homes today you will find a whole record collection, all of the families photographs, house accounts, tax accounts and that blockbuster novel that you are only two sentences away from finishing languishing on on one fragile magnetic disk rotating at 7200rpm. Despite the fact that a DVD Writer only costs 35 pounds or so no-one makes a back up of anything. I have lost track of the number of times people have come to me saying the system is dead and they have their 'whole life' on - can I get it back?

The answer is, 'Just walk with me across this lake and I will see what I can do.'

### What Are We Backing Up?

This may seem to be a silly question but we should think seriously about what it is we need to archive before embarking on this task. QL systems are, on the whole, very forgiving. There is very little you can do to them that will stop them from functioning completely and next to nothing that will make a system irretrievable. Most of the programs you have you will have bought on floppy disk so, if these have been kept in a safe place, you can restore them straight away. Many of the updates to these programs will also be on floppy disks so the same applies. QDT, QPC2 and QPCPrint now ship on CD so that is even better.

Making a list of the items you want to backup is often a good idea. As you run through the list whilst doing the backup you will find other items you may have forgotten so add these to the list while they are being copied to keep the list as comprehensive as possible.

Some of the programs may have been downloaded from the Internet and some of the upgrades could have come via Jochen Merz's Upgrade site so, unless you want to download them all again, it is probably best to make sure these are on the list.

Your Boot file may have taken ages to get into its current shape so that should be on the list.

Of course any DATA files, documents, spreadsheets etc. should be on the list because these are the very items you most want to keep.

Some programs, such as Qascade, ProWess and QDT, have setup files which are read in as the program starts and give it the parameters it needs to do all the things you want it too and control the look of the program. Try to identify these and add them to your list.

Level 2 Config program can save the settings to the Menuconf\_inf file. Adding this to your back up list will save a lot of time when it comes to re-installing programs.

I am sure you will have a lot of other stuff that needs to be backed up but I think you get the idea. Remember that an orderly backup system will make for an orderly restore and save a lot of time.

## A Few Don'ts

OK then first we will start with a few things not to do or, at the very least, to try to avoid. Some are simple and common sense but let us list them here anyway.

If you are about to save vital data and configuration there is absolutely no point in getting a bunch of old floppy disks and using them. Get a new set of disks, format them and look at the display at the end of the formatting process. It should read 2871/2880 SECTORS. If the first figure is substantially less than 2871 then **THROW THE DISK AWAY**. The first figure is the available disk space and the second is the total space on the disk. They differ because the 9 sectors are being used to store the disk map including any bad sectors that cannot be written to. A very much smaller number indicates that the disk is faulty.

**Do Not** use just one set of backup disks. Use a backup regime that consists of two sets of disks. Label the first set 'BACKUP 1' and the second 'BACKUP 2'. When you run the first backup do it to 'BACKUP 1' write the date on it in pencil and store the disks away. When you come to run the second backup, after whatever period you think is most viable, do it to 'BACKUP 2' and write the date on the first disk of that set in the same way. When you run the next backup session revert to the disks labelled 'BACKUP 1'. This is called the 'Mother and Daughter' method and ensures that you have two copies of your backup files and that these are always one session apart.

Do not back up to another partition on the same hard drive. It is tempting to do this, given the size and cheapness of modern hard drives, but, although it does offer some protection against deleting files you suddenly find you need or overwriting valuable data with rubbish because you have chosen the wrong file name, it does not offer complete protection. The most common cause of data loss is the failure of the drive itself. If your drive has WIN1\_, WIN2\_, WIN3\_ etc on it and you back up from WIN1\_ to WIN3\_ then the data is gone when the drive dies.

Do not assume that, at the end of the session, the data is on the chosen medium. You may not have seen an error message but it may not have written there anyway. Always choose a couple of disks at random and read them - preferably on a different machine so you know that data is there and viable.

## Finally, a couple of DO's

Do try to run your backups with no other programs running. QL programs are pretty good about the way they open and close files (Let's not even think about Archive) and you do not often suffer from files being 'In Use' but running on a clean machine gives you best memory overhead and does ensure that all the files are available to you.

Do store the backups properly - preferably somewhere that you can remember where they are if you need them. Sticking them in a cardboard box marked 'Photos' with a bunch of fridge magnets is not going to do them any good at all.

## How do I do it then?

This all depends on the system you are backing up and what you want to back up to. I will leave discussion of dedicated backup programs to the end of this article.

### 1. Backing up to floppies

It can be done in a very simple way. You can, for instance, just go to the command line and type:

```
COPY WIN1_XXX to FLP1_XXX
```

All very well but a bit long winded if you have a lot of stuff to backup. You can use any of the file managers available for QDOS/SMSQ systems. QPAC2 will allow you to select a whole batch of files and copy them to different device. It does have a couple of drawbacks, however. It does not, for instance, allow you to span disks and it will not warn you if the size of the files you have selected is too much for the destination device. If

the destination device becomes full it will stop and tell you and it will indicate which files have been copied but, if the device becomes full during the writing of a file it will leave the header on the destination device with little or no usable content. This can lead to incomplete backups. There is also an anomaly in the way it copies files. 'COPY', from the command menu will copy the file and date it for the system date when it is copied. If you want to preserve original date on the file you have to use 'BACKUP'. This command has its own restrictions but we will not go into these here.

Disk Mate 5 will tell you the size of the files you have selected and does add the totals so you can get a good idea if it will fit the intended medium but again it is a long winded way of doing things if you backing up a lot of files.

Cueshell does not give you any information on how much data you are moving either but its copy options are 'BACKUP' and 'UPDATE' with the date being preserved by the default 'BACKUP' option.

## 2. Backing Up to a 2nd Hard Drive

Things get a lot easier when you are backing up to another large medium. Programs of choice here are Cueshell and Disk Mate 5 both of which will copy whole subdirectories and recreate directories as they go. Disk Mate 5 has a lot of sophisticated options but these are not really useful for backup purposes. Cueshell is probably the best to use since it is simple to select whole subdirectories and drag them to the destination device. This is fine for the first backup but subsequent copies do tend to throw up a lot of 'Overwrite/Skip?' messages. If you already have the data on the destination device from a previous backup it is better to use QPAC and backup each directory separately using the 'TREE' command to open all sub-subfolders and then selecting 'ALL'. You will still be offered the overwrite option but only once.

## 3. Other Qubide options.

The Qubide hard drive interface can be used, if the firmware is up to date, to connect to other devices than just hard drives. It is possible to connect an IDE Compact Flash drive or ZIP drive. Not all IDE compact flash adaptors will work so it is best to ask other users to find out which ones they are using. Only IDE ZIP devices will work and these are no longer manufactured but they are available. Remember they do need to be formatted and, in both cases, they do need to

have a medium in the drive when you do this. It may sound silly but I did have a user spend a few hours on the phone to me trying to get his drive to work before I realised that he was trying to format the 'device' without a disk in it. Although the Qubide can, with the correct software, read a CD it cannot, as far as I know, write to it.

## 4. Backing up across the QL Network

This is possible using the same methods as 2. above. You should, however, remember that the QL network can be a little flaky and is very slow. It is best to avoid this method unless you know you have rock solid communication between the two machines.

## 5. Backing up using SERnet

This is a much more solid method than the QL network and a lot faster. It is best to have at least Hermes replacing the 8041 chip in the QL and superHermes will make it faster and better. It is the best way to pass data between different machines - QL to Q40/Q60/PC with emulator. There have been various discussions of how to cable and configure this in back issues of this magazine.

## 6. Backing up QPC2 / QXL Systems

These are the simplest of all to backup. All data in these systems is held on 'QXL.win' files on the hard drive of the native system. What you see when you run the emulation system is WIN1\_ with all its sub directories. What you see from the PC side is just one large file called QXL.WIN. If you use the PC's file management system you can just copy that one big file to another drive or USB stick or any other device attached to your system which can be written to.

One thing to remember when writing QXL.WIN files to CDs is that they have the write protect tag enabled when they are written. If you then copy that QXL.WIN-file to another machine the tag is still enabled. You can open a file under the emulator, write to it, and save it with no error message popping up. Next time you open the file, however, it is unchanged. You can change the Write protect tag by right clicking the QXL.WIN file in Windows and selecting 'Properties' and clicking on the 'radio' button at the bottom.

## 7. Backing up across a PC Network

If you have two machines on a PC network and they both are running QXL/QPC2 emulators you can easily keep them backed up. First you have to 'Map' the drives in Windows which will give

them a drive letter. You can do this from the File Explorer window. Navigate across the network to get a file list on the other machine. Highlight the drive name or subfolder that has the QXL.WIN file in it, go to 'Tools' and choose 'Map this drive' It will then give you the option of a letter and a name for the mapped drive. Once you have done this you should be able to access the drive from the machine you have mapped it from. Then go to QPC2's configuration window and find an unused WIN slot (say Win8). Navigate to the drive in Windows you have just mapped and find the QXL.WIN file you want to use. Select this and save it. When you use the emulator next you will be able to copy from WIN1\_ to WIN8\_ as if it is on the same system but it will be on another machine. Perfect for backups and very fast. Do the same on the other machine to make a two way link.

## Some Backup Utility Programs

Here are four backup programs available for QDOS/SMSQ systems. Winback and The Knight Safe do have problems with the current incarnation of SMSQ/E but, since it is always best to run these programs as a stand-alone application it should be possible to run them on native QDOS /QDOS classic on all platforms except QPC2 which, as I described above, is simple to back up without the use of a dedicated program. I have included a few of the features as described by the authors themselves in the help files and other documentation.

### Norback by Arvid Borretzen

Status - Freeware

Available From - Qubide hard drive utility disk.  
Most QL-download sites

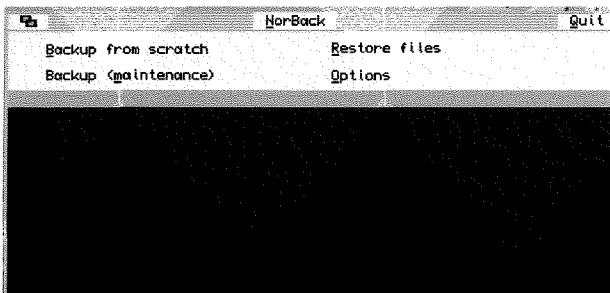

- can span disks
- can restore a single file from a backup
- will recreate Directory Trees
- Pointer Driven

### TGBack by Thierry Godefroy

Status - Freeware

Available From - Thierry Godefroy's Website & Other Download sites.

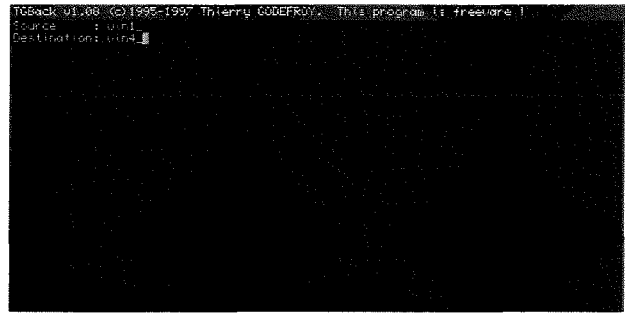

With TGBack you can:

- backup a whole hard disk partition (ex: win1\_),
- backup a part of a directory tree recursively (ex: win1\_sys\_ and all sub- directories in win1\_sys\_),
- backup a whole hard disk except specified sub-directories,
- make differential backup of a partition or a part of the directory tree (only newer files are copied to the destination) and optionally synchronize the destination (deleting files that are no more present on the source),
- just build a file and directory list and give up.
- not pointer driven

### Winback by Norman Dunbar

Status - Freeware

Available From - Thierry Godefroy's Website & Other Download sites. (Thierry's may be slightly out of date - try Dilwyn Jones' site))

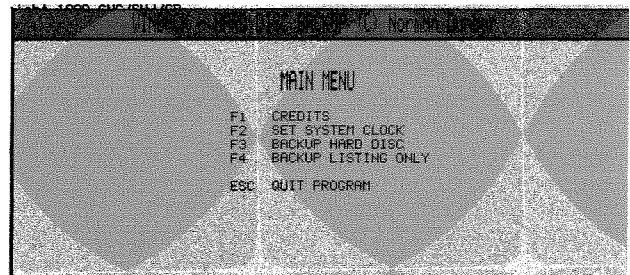

- Originally written to back up the Miracle Hard Drive
- Can Split large files over two or more disks
- not pointer driven but menu driven from the keyboard

Norman Says: 'It backs up a Miracle hard disc and/or a floppy disc (some people used it to back up their ED discs). It checks whether a file needs backing up by reading one of the dates in the header although you can set it to do a full backup at run time.

It can backup to floppy, another hard drive, over the network whatever. When a file is too large to fit on a floppy, you can either change discs or split the file. At present - with SMSQ/E - there is a problem as Tony Tebby decided to use CHR\$(0) and CHR\$(1) as special characters (directory separators I think) internally, so the split and join

# TF Services

## Compswitch

A UK 4-way trailing socket designed to switch off computer peripherals automatically when the computer is switched off, or (in the case of an ATX computer) when it auto-powers down. *Compswitch* has one control socket, and three switched sockets. Can be used with lights/hifi/monitors—ie a QL monitor can be used as a switch control.

Cost **£24**

## superHermes

A major hardware upgrade for the QL  
All Hermes features (working ser1/2 at 19200, independent baud rates/de-bounced keyboard/keyclick) IBM AT kbd I/F // HIGH SPEED RS232 at 57600// serial mouse port and 2 other RS232 inputs// 3 I/O lines // EEPROM

Cost (including manual/software) .....**£90** (£92/£93)  
IBM AT UK layout Keyboard.....**£11** (£13/£15)  
Serial mouse.....**£8** (£8.50/£9)  
Capslock/scrolllock LED .....**£1** (£1.50/£1.50)  
Keyboard or mouse lead .....**£3** (£3.50/£3.50)  
High speed serial (ser3) lead.....**£4** (£4.50/£4.50)

Hermes available for **£25** (£26/£27) Working ser1/2 and independent input, debounced keyboard.

SuperHermes LITE: All Hermes features (see above) + an IBM AT keyboard interface only.

Cost (incl keyboard lead) .....**£53** (£54/£55)

## QL REPAIRS (UK only)

Fixed price for unmodified QLs, excl microdrives. QLs tested with Thorn-EMI rig and ROM software.

**£27** incl 6 month guarantee

## Minerva

The ORIGINAL system operating system upgrade

OTHER FEATURES COMMON TO ALL VERSIONS

DEBUGGED operating system/ autoboot on reset of power failure/ Multiple Basic/ faster scheduler- graphics (within 10% of lightning) - string handling/ WHEN ERROR/ 2nd screen/ TRACE/ non-English keyboard drivers/ "warm" fast reset. V1.97 with split OUTPUT baud rates (+ Hermes) & built in Multibasic.

First upgrade free. Otherwise send **£3** (+£5 for manual if reqd).  
Send disk plus SAE or two IRCs

MKL..**£40** (£41/£43) MKII..**£65** (£66/£67)

**MINERVA RTC (MKII) + battery for 256 bytes ram.**  
**CRASHPROOF clock & I<sup>2</sup>C bus for interfacing. Can autoboot from battery backed ram. Quick start-up.**

## QL RomDisq

Up to 8 mbyte of flash memory for the QL  
A small plug in circuit for the QL's ROM port (or Aurora) giving 2, 4 or 8 mbytes of permanent storage - it can be thought of as a portable hard disk on a card, and reads at some 2 mbytes per second.  
Think of it - you could fully boot an expanded QL, including all drivers/SMSQ etc off RomDisq at hard disk speed with only a memory expansion needed.

2 mbytes RomDisq.....**£39** (£40/£41)  
4mbytes RomDisq.....**£65**(£66/£67)  
8 mbytes RomDisq.....**£98** (£99/£100)  
Aurora adaptor.....**£3** (£3.50/£4)

## MPLANE

A low profile powered backplane with ROM port

A three expansion backplane with ROM port included for RomDisq etc. Aurora can be fitted in notebook case and powered off single 5V rail - contact QBranch for details. Two boards (eg Aurora and Gold Card/Super Gold Card/Goldfire fixed to base. Suitable for Aurora (ROM accessible from outside) & QL motherboard in tower case. Specify ROM facing IN towards boards, or OUT towards back of case.

Cost .....**£34** (£35/£36)

## I2C INTERFACES

Connects to Minerva MKII and any Philips I<sup>2</sup>C bus

**Power Driver Interface** 16 I/O lines with 12 of these used to control 8 current carrying outputs (source and sink capable)

2 amp (for 8 relays, small motors).....**£40** (£43/£44)

4 amp total (for motors etc).....**£45** (£48/£50)

**Relays** (8 3a 12v 2-way mains relays (needs 2a power driver).....**£25** (£28/£29)

**Parallel Interface** Gives 16 input/output lines. Can be used wherever logic signals are required.....**£25** (£27/£28)

**Analogue Interface** Gives eight 8 bit analogue to digital inputs (ADC) and two 8 bit digital to analogue outputs (DAC). Used for temp measurements, sound sampling (to 5 KHz), x/y plotting.....**£30** (£31/£32)

**Temp probe** (-40°C to +125°C).....**£10** (£10.50/£11)

**Connector for four temp probes**.....**£10** (£10.50/£11)

**Data sheets**.....**£2** (£2.50/£3)

**Control software & manual (for all I/F)**.....**£2** (£2.50/£3)

## QL SPARES

Keyboard membrane ..... no longer on sale

1377 PAL .....**£3** (£3.50/£4)

Circuit diagrams.....**£3** (£3.50/£4)

68008 cpu or 8049 IPC.....**£8** (£8.50/£9)

8301/8302 or JM ROM or serial lead.....**£10** (£10.50/£11)

Power supply (sea mail overseas).....**£12** (£19/£23)

Other components (sockets etc) also available

Prices include postage and packing (Airmail where applicable) Prices are: UK (Europe /Rest of world). Payment by cheque drawn on bank with UK address, postal order or CASH! I can no longer accept card payments as UK only does PDQ transaction. SAE or IRC for full list and details

22 Feb 03

29 Longfield Road, TRING, Herts, HP23 4DG

Tel: +44 (0) 1442-828254

Fax/BBS: +44 (0) 1442-828255

tony@firshman.co.uk

http://www.firshman.co.uk

features may not work. You could have up to 96 file sections on your backup medium/media and then, on restore, merge them all together again to make a single large file.

The manual is a quill doc file so can easily be passed through one of the many incarnations of QStripper to produce a text file for easy (!) cut & paste.'

### The Knight Safe 3 - by Mark Knight

Status - Commercial but no longer supported by the author

Available - from QBranch.

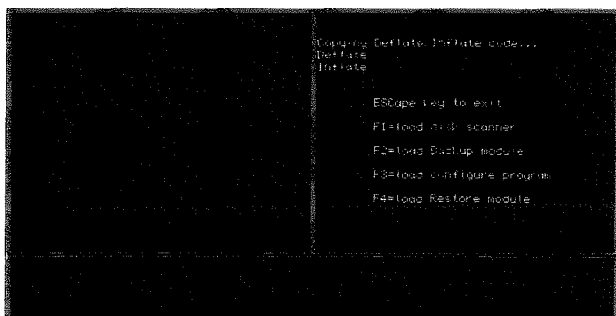

- most recent and sophisticated of all the backup programs
- uses a compression program from Jonathan Hudson to reduce storage size.
- can assess disk space, number of disks required
- very fast
- writes a log so that the user knows in which archive disk each file is kept.
- Will recreate Directory Trees
- not pointer driven but menu driven from the keyboard
- uses the Turbo Toolkit

## Conclusion

This just about sums up the business of backing up systems. One area I have not been able to assess in any depth is that of emulators (other than QPC2). Most of the methods described above should work with no problems on these systems but we would welcome any comments, tips or special methods other people may use on their own systems.

# Toolkits

by David Denham

We've all heard the name "toolkit", but what does it really mean?

Supposedly, it's a programming aid of some description. On some computers it might be a set of software tools designed to do a specific task, such as providing a ready made set of routines which programmers can use to simplify writing complex software.

On the QL, our interpretation of the word was influenced from day one by Sinclair and Tony Tebby, when Toolkit 1 and Toolkit 2 were released.

Toolkit 1 was a predecessor to Toolkit 2. It was sold on microdrive cartridge by Sinclair Research's software division. A short while later in the life of the QL, Tony Tebby released the early versions of the Toolkit 2 we all know and love today.

The early Toolkit 2 was usually supplied on a 16K EPROM, which plugged into the back of a QL via the EPROM slot. There was also a version you could get on microdrive cartridge, which let you select which parts of it you wanted, which was very useful on an unexpanded 128K QL where memory was limited. Cut down versions appeared on various disk interfaces - the commands were the same as those in the full Toolkit 2, but not all the commands were there, just those relevant to the disk interfaces.

Toolkit 2 gave us a whole set of new commands in SuperBASIC and provided many facilities like improved network handling and default directories and wildcard handling and so on.

And in so doing it fashioned how we perceived the term "toolkit" - most of us saw it as just meaning an EPROM or software package which gave us extra commands in SuperBASIC.

These days, many systems come with Toolkit 2 built in. Take the disk interfaces from Miracle Systems (Trump Card and Gold Card for example) which had a full implementation of Toolkit 2 on board. Those who use SMSQ/E have pretty much all of Toolkit 2 included in SBASIC as standard on SMSQ/E systems.

Tony Tebby currently permits limited distribution of Toolkit 2 for those who need it to use on QL emulators, for example.

What I hope to do with this article is to look at some of the available toolkits, those which provide extensions to SuperBASIC or SMSQ/E. There are quite a few out there and almost all are free and you can get them from PD libraries and QL websites.

Although I've never seen the book, I'm told that most QL toolkit extensions are listed in Rich

Mellor's SuperBASIC Reference Manual - see RWP Services adverts for details, although be warned, it does cost £20.00!

## Installing Toolkits

Most toolkits are supplied on disk. These are usually installed into the resident procedures area with the usual RESPR, LBYTES, and CALL statements.

A RESPR command reserves some space in the resident procedure area. This space is usually the same size as the length of the toolkit file on disk. Most toolkits come as just one file, which contains all the extensions to basic in a single file. The filename usually has a 3 or 4 character extension or suffix like one of these examples, although some have no filename extension and some have less common filename extensions:

`_BIN, _CDE, _REXT, _RXT, _EXT`

The BIN is usually short for Binary, CDE for Code, REXT for Runtime Extensions and EXT for Extension(s). As long as the memory requirement is the same as the length of file, you can find out how much space to reserve with the FLEN function which tells you the length of the file. Suppose you have a toolkit called

`FLP1_TOOLKIT_EXT`, the command  
`PRINT FLEN("\FLP1_TOOLKIT_EXT")`

will tell you how much memory needs to be reserved.

The toolkit file is then usually loaded into this memory area with an LBYTES command, and then a CALL command is used to make the computer run a small piece of code in the toolkit which links it into the system and tells the QL the names of the new commands and functions contained in the toolkit. Here's an example. We assume the length of the file TOOLKIT\_EXT is 1234 bytes:

```
100 base = RESPR(1234)
110 LBYTES FLP1_TOOLKIT_EXT,base
120 CALL base
```

Most toolkits are started by calling the base address of the block of code when it's loaded into memory. Some have specific and rather different requirements, which will normally be documented in their instructions. Some toolkits have different requirements when you link them into a compiled basic program, but that's a completely separate subject in itself.

The above three lines are usually included in a boot file of some sort. Most toolkits come with boot programs of their own, and by looking at these you can usually work out how to add them

to your own boot program just by looking at the RESPR/LBYTES/CALL commands. Some programs go to great lengths to set up fancy screens during loading. The ones with the largest boot programs are usually the troublesome ones to integrate into your own boot programs, because it's hard to extract the minimal facts you need.

If your system has a command called LRESPR you can often use this to replace the above three lines:

```
100 LRESPR FLP1_TOOLKIT_EXT
```

An LRESPR command automatically works out from the length of the toolkit file how much memory to reserve, loads the file and does a CALL to link the toolkit into basic.

## The Order in a BOOT Program

This is not a hard and fast rule, and it gets easier with experience. By and large, QL code is not too fussy about which order the toolkits are loaded, but there are some simple rules which can help:

If your system has a copy of Toolkit 2 which requires a command to start it, this should come early in the boot program. For example,

```
100 TK2_EXT
```

is an example of a command needed on some disk interfaces to make the built in toolkit 2 become visible to superbasic.

If you use screen accelerators like Speedscreen or Lightning, it is generally best to install these first in your boot system, before other basic extensions and toolkits.

If your system uses pointer environment which is provided by files called PTR\_GEN, WMAN and HOT\_REXT, these are generally installed before toolkits.

Pointer environment has something called the hotkey system, which is usually woken up by a command like HOT\_GO. The toolkits are usually loaded before this command. Likewise, toolkits should be loaded before any programs are executed. This is because any jobs running mean that the RESPR area cannot have space allocated while a program is executing or the hotkey job is running - you'll get an error message like "Not Complete" in this case.

So your boot program will probably build up in this order:

- TK2\_EXT if required to make Toolkit 2 available.
- Install any screen accelerator software.
- Install pointer environment if used.

- Install any toolkits.
- Define any hotkeys etc
- Issue a HOT\_GO command to wake up hotkeys if used.

These are only simple guidelines and may well vary from program to program.

## Some Useful Toolkits

### TURBO TOOLKIT

Probably the two best known toolkits are Turbo Toolkit and DIY Toolkit. The Turbo Toolkit is of course part of the Turbo Compiler software, but can be used without Turbo if you want. Since Digital Precision stopped selling Turbo, George Gwilt has continued work on the compiler and people like David Gilham have put in a lot of work on Turbo Toolkit to make it better suited to the needs of modern QLing. These days, Turbo Toolkit comes in three versions:

TURBO\_TK\_CODE is the standard version, which can be used on just about any system.

TURBO\_SMS\_CODE is a slightly smaller version which is intended for use on SMSQ/E systems.

TURBO\_REM\_CODE is a version specially written for inclusion in a compiled basic program. Using a new facility in modern versions of Turbo it can be physically linked into a Turbo compiled program, giving the advantage that for people who don't use Turbo all the extensions become part of the program, meaning you don't have to install Turbo Toolkit before executing the program.

A lot of extensions in the Turbo Toolkit are specific to Turbo, for example, the extensions which let you access basic data structures and the compiler directives, whereas others are more general, like the function telling you where the system variables start in memory, commands to search memory and move blocks of memory content around, and the extensions to help with writing data in internal QL formats to files. Turbo Toolkit treads a fine line between being specifically for use with the Turbo Compiler and use as a useful stand alone toolkit.

### DIY TOOLKIT

DIY Toolkit is (as its name implies) a set of small toolkits, sometimes just one extension each. It was originally a series of articles in the QL World magazine. Simon Goodwin gathered his articles and files into a collection of toolkits and gave them all titles and volume letters, until he appeared to have used all the letters of the alphabet!

The extensions available are quite diverse and impossible to summarise briefly. You get an improved input command, actually implemented as a function called EDLINE\$. You get a fast memory search extension. You get Flexynet software to extend the use of the QL network ports. There's a trap handler to help make use of operating system trap calls. All in all, there's about 24 volumes spanning three floppy disks providing just about anything you could want by way of basic extensions. They come with comprehensive documentation and Simon has even thrown in the source code of many of the extensions, so QL programmers can study the code and how the author approached the task.

DIY Toolkit is technically Cardware - you are able to make free use of the DIY Toolkit but the author requests you send him a postcard if you like and use the DIY Toolkit - hopefully he has a large postcard collection by now!

This 3 disk set of extensions is extremely useful, but if you haven't got the original magazine articles, it can be rather heavy going ploughing through the extensive set of doc files on the disks to familiarise yourself with it all. For programmers, it's great, you can just pick and choose the extensions you need and include them with your programs.

### DJ TOOLKIT

A surprisingly useful little toolkit written by Norman Dunbar. The "DJ" apparently comes from "Dilwyn Jones" who drew up the specification and used it for some of his DJC programs and later PD programs. It does seem to be the kind of toolkit that a QL programmer would use although it's just as useful for those of us writing super-basic programs for our own use. It includes commands for moving memory around, searching memory, filling memory with specific values, file opening functions, file header functions, file data write and read functions for internal format data, heap allocation, system variables, font extensions, QPTR detection, level 2 file system detection, screen size calculation and others. The more I use this little toolkit, the more I like it. It doesn't replace toolkit 2 and doesn't seek to do so, but it's extremely useful. And it comes with some demonstration listings showing how to use the extensions.

### EXISTS

This is a single extension written by Phil Borman. It has one purpose - it checks if an extension exists on your computer and returns a value of 1



if it does, or 0 if not. At first glance, not that significant until I realised that it could be used indirectly to see if certain modern facilities exist on your system.

For example, if you want to check if colour drivers exist on your system, one way of doing it would be to see if extensions like DISP\_COLOUR are available:

```
IF EXISTS('DISP_COLOUR') = 1 THEN
  REMark set a GD2 colour
ELSE
  INK #0,7 : PAPER #0,0 : CLS #0 :
  REMark mode 4 colours
END IF
```

Should you need to see if your program is running on a system with Window Manager 2, one way would be to check the version of SMSQ/E with VER\$, like this:

```
window_man2 = 0 : REMark assume no
window manager version 2
IF VER$ = 'HBA' THEN
  tmp$ = VER$(1)
  IF tmp$ >= '3.00' THEN window_man2 = 1
END IF
```

The first line checks to see if we're running on an SMSQ/E system (where SBASIC has the version letters 'HBA'), then uses VER\$(1) to check the SMSQ/E version number. This usually works well enough, but doesn't help when your program is running on a QDOS system with pointer environment version 2, which can also have a version 2 window manager (also known as WMAN2). So another approach which works on both QDOS and SMSQ/E is to see if the SBASIC keywords relevant to Window Manager 2, like WM\_INK or WM\_PAPER, are present:

```
window_man2 = 0
IF EXISTS('WM_INK') = 1 THEN window_man2=1
```

A small piece of software which does exactly what it says on the can, as they say. Surprisingly useful.

## PDTK

A small toolkit from Mark Swift. It provides quite a few extensions along the lines of those found in toolkits like Toolkit 2. It was originally written to be included with one of the Amiga emulators, but can be used on most systems. It's only about 4 kilobytes in length and the author provides the source assembler code for those wishing to study the code. The instructions are brief yet pretty comprehensive, although there's little by way of examples. Especially useful with emulators which don't have toolkit 2 included.

## Hyperbolic Functions

This is a small set of mathematical functions, providing SINH, COSH, TANH, COTH, ARSINH, ARCOSH, ARTANH and ARCOTH. There's no instructions, but there is an assembler source file in German. Might prove useful for those wanting to use these functions, the only such extensions I've seen for the QL.

## PEX

I've never really got this to work for me, but the idea is sound and possibly it's my QL system which isn't up to the job. The basic purpose is to allow programs to write to background buried windows. It seems to need a Minerva ROM on a QL, or it works on older versions of SMSQ/E which don't have the facility to write to buried windows like the latest versions do. There are other associated packages like PIE, PICE and NICE.

## TINY TOOLKIT

This is a small but quite extensive toolkit. It contains about 70 extensions in a 9 kilobyte long toolkit, with instructions in both German and English. It was written by Matthias Leidig many years ago and since updated by Rich Mellor. It contains a very diverse range of extensions, some extremely useful and some you may not use very often. It's a bit of an unknown quantity as far as I'm concerned, as I haven't used it very much.

## QVIEW TOOLKIT

This is a toolkit written by the individuals at QView who originally developed the Minerva ROM. The toolkit was apparently developed for use with their bulletin board system, to avoid dependency on other commercial toolkits at the time. It's only 1K long but the extensions are all useful. One good feature is that the extensions start with the letters TT, so the risk of a clash of names with other toolkits is small. The extensions include the common heap handling, file open and delete functions, find strings in memory, set QDOS character increment value (like CHAR\_INC in TK2), an extension to help with calling QDOS trap #3 operations, peek and poke strings in memory and so on. Quite a good little toolkit for its small size, although most of the extensions are available in more modern toolkits.

## DISPLAY CODE

This one appeared in QL Today a couple of years ago. It's aimed directly at people who want

to make use of facilities in modern QL systems, but in a way which does not make them necessarily fail to work on older systems where possible. It includes extensions to check the size of the screen, mode number, whether pointer environment is present, version numbers of QDOS, pointer environment and window manager, whether GD2 colour drivers are present or not, whether window manager 2 is present or not, screen width in bytes if you need to read or write direct into screen memory, system variable addresses and so on. Most of this can be done from SMSQ/E, but using the SMSQ/E functions may mean your program will only run on SMSQ/E systems. With a bit of care, you can use this small set of extensions on QDOS or SMSQ/E if you need to try to ensure your program works on both, or uses different routines for both operating systems. If you use this one, it's best to get version 2 which added more extensions than were originally printed in QL Today. It's biased towards screen handling rather than a general toolkit like those I've mentioned.

## Conclusion

You will probably guess I've been playing with too many toolkits. It does sometimes feel like I spend more time on a QL than is good for me, but the QL has provided me with so much satisfaction over the years that I'm only sorry I didn't get into it in more depth years ago, I've only really made a determined effort to further my knowledge since I've been writing for QL Today - I am so glad we still have a great QL magazine (grovel, grovel).

I've obtained the toolkits from PD libraries over the years and from websites like those of Thierry Godefroy and Dilwyn Jones. The latter website has a page devoted to toolkits if you'd like to download some of those I've mentioned as well

as many I haven't mentioned, as I've never used them: [www.dilwyn.uk6.net/tk/index.html](http://www.dilwyn.uk6.net/tk/index.html)

By far and away the most essential toolkit is the original Toolkit 2 and everyone should have it. Most modern QL systems will have some form of it and for those who don't you can now get copies of it from the web (e.g. from Dilwyn Jones's website).

## Warning

As you use these toolkits, you will find that there is a degree of overlap in most toolkits of a general nature.

So, a small afterthought: beware of name clashes. Several toolkits have the same name for some of their extensions and this can cause some problems if the extensions do different things. As a rule of thumb, if you are using a machine with a JM or AH ROM version, the first extension installed takes precedence over second and later definitions (meaning that only the first one loaded works) whereas later versions (JS, MG, Minerva etc) seem to take the most recent loaded version of an extension as the one to use. There have been times when I've worried why something wasn't working as I expected it to and I discover that I have loaded more than one extension with the same name and managed to confuse the QL more than a little! Sometimes, printing a list of commands with the Toolkit 2 extension EXTRAS can help you spot multiple definitions, especially if you send the list to a file and sort them:

```
OPEN_NEW #3, RAM1_TEMP_FILE
EXTRAS #3
CLOSE #3
```

and load the file created into your favourite sorting program to make an ordered list so that you can see multiple definitions together in the list.

# Bye-Bye Byfleet

by Geoff Wicks

Are we British cleverer than the continentals? They explode their fireworks on New Year's Eve to frighten the demons away. We explode ours on 5th November to celebrate the day when a Mr. Guy Fawkes attempted to blow up parliament and all the politicians.

(Sound of breaking glass as armed police raid the QL Today office to arrest the editor for praising an act of terrorism. This could be the first QL Today article scribbled on a piece of

toilet paper smuggled out of Paddington Green police station.)

This year the Byfleet Show was held on Guy Fawkes Day. Not an auspicious choice as the previous two Byfleet Shows had been damp squibs with a poor attendance of both traders and punters. Ken Bain had been reluctantly persuaded to hold another show this year, and this workshop raised many questions about the future of UK shows.

This year there was a better trader attendance. Main absentee was Jochen Merz, partially on health grounds. However there were never more than 20 people in the hall at any one time, but the many comings and goings make an estimate of total numbers tricky. Probably about 30 people attended the show, and that total includes the traders, the organisers and the Quanta committee members.

Roy Wood and I had both prepared presentations. Roy planned to demonstrate the latest version of QDT, and brought a computer projector with him. I had prepared a "live" version of my Perfect Partners article from the last QL Today. However we decided in conjunction with Ken Bain that numbers were too few for

the presentations to be worthwhile. Indeed in a strange sort of way talks may have spoilt the atmosphere. Numbers may have been few, but people were well occupied, and there were numerous private conversations going on. Most of those present appeared to be enjoying themselves.

Main traders' news at the show was the decision of Just Words! to make all its commercial software freeware from the beginning of the new year. Recently Just Words!

has redesigned its website to facilitate this process and to keep the brand name alive. Citing the example of semi-trader Dilwyn Jones, Just Words! will continue to set up a stall at shows.

As a foretaste of the future Just Words! was offering all its programs for just £1 each. One person out for a bargain decided that the show advert "Everything £1 per item" was to be taken literally. He triumphantly used this special offer to seize the Just Words! laptop. Little did he know that it is 8 years old, has a broken lid following a fall and is probably no longer worth a pound.

Another group with an unintentionally unfortunate advert was Quanta. The committee had booked a room for a committee meeting, but, given the poor attendance, decided to hold this at their table in the main hall. They had forgotten that in front of them was a notice saying in large letters that, as a special offer, they were available at 10p each. Even I, as one of their sternest critics, felt they were undervaluing themselves.

However an examination of the small print showed that it was second hand DD disks and not the committee members that were being sold off.

Quanta provided us with a new look chairman. He entered the hall sporting a long white beard fol-

lowed by Roy Kempton carrying the posh-looking Quanta case. For a moment I thought there had been a coup-d'état and we were seeing Tony Blair's replacement together with his



aide carrying the nuclear codes. Others speculated about the religion to which the chairman had obviously converted. Or perhaps he had been moonlighting as Father Christmas. There was a more mundane explanation. John Mason has injured his right arm, which is healing very slowly and he is unable to shave.

No show report is complete without a word of thanks to the caterers. Byfleet once again maintained the QL tradition of healthy and cheap eating.

The big topic in informal conversations was the future of workshops. Ken Bain was adamant that this would be the last Byfleet show. He had organised it against his better judgement after some arm twisting by Quanta and myself. I agree with Ken that there is little point in trying again next year.

UK QL-ers are faced with a reality that there are now only two show locations, Hove and Manchester. In an informal conversation I had with the Quanta committee, they were clear that they wish to keep to the present policy of alternating the AGM between the north and the south. They have already advertised for bids to hold the 2007 AGM at a Southern or Midlands location on either 14th/15th April 2007 or 28th/29th April 2007.

In practice, unless unexpected bids come in, the chances are that the 2007 AGM will be in Hove and the 2008 AGM in Manchester. But what form should these shows take?

There are many Quanta members living within the catchment area of both locations. The membership survey I did in 2004 showed that there were 69 members in the North West and the Midlands, and 110 in London, the Home Counties and the South East. The numbers will have fallen since then, but in practice only 14 attended the last Manchester AGM and 22 the last Hove AGM. In both cases up to a half of the attendees came from outside the immediate catchment area. Can we expect a better attendance in 2007 and 2008?

If we are honest and realistic we have to expect future UK shows to be badly attended. What are the implications of this for the nature of these shows? Here are three possibilities and, one hopes, QL Today readers can think of more.

From my conversations with the Quanta committee I had the impression that they are in favour of two day shows. Manchester has done this for a number of years. On the Saturday there has been a traditional show day in the afternoon followed by a social event in the evening. This is regarded as the main trading day, which fits in with the long experience of traders that only the first day of a



two day show is worthwhile. The Sunday then starts with talks and demonstrations and finishes with the Quanta AGM.

Another potential model is the North American style of show, which relatively few people attend. This then has the form of a more social event in which old friends meet together for a weekend in a hotel. There is also an opportunity for lectures and demonstrations. Some planned and some extempore.

A third model would be to scrap shows completely and just hold a Quanta AGM. This would make life very easy for the Quanta committee. All they would have to do is book a room for half a day, and if scarcely anyone attended it would not matter as there is no minimum quorum. It would be

theoretically possible to hold an AGM with just two people present. Of course, if things were as bad as that, there would not be much point in Quanta anyway.

So where do we go from here? Do we want 2 day or 1 day shows? What form should demonstrations and lectures take? How much time should be devoted to social activities? Do we want a "one stop shop" similar to QL is 21, but on a smaller scale? Should we now start to think of holding traderless shows?

Or is it time to face reality and scrap UK shows altogether? After all, we have QL-ers all over the world, but only 3 (or is it 4?) lands hold regular shows, the UK, the Netherlands and USA/Canada. Is it now the internet and not shows that binds us together (and with more than a little help from QL Today)? And suppose we reduce the

frequency of UK shows or scrap them all together, what are the implications for the future of Quanta? How can it continue to serve its members?

Or should we now say that Quanta has served its purpose, is no longer relevant to the QL scene, and the time has come to wind it up?

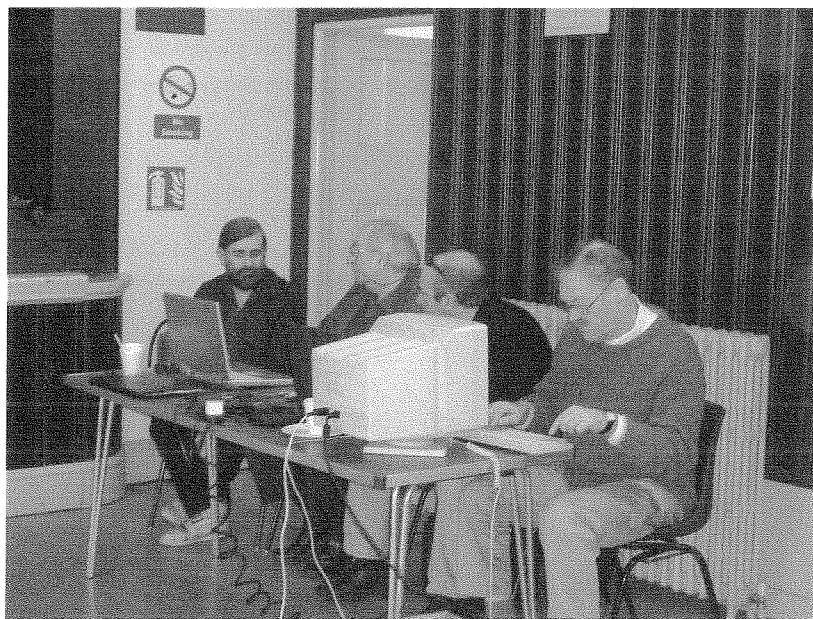

#### Postscript:

Since this article was written the date of the 2007 Quanta AGM has been provisionally fixed

for the weekend of 14th/15th April. A list of hotels will be available for any person needing them and by sufficient interest that will be a show dinner on the Saturday evening. Both Roy Wood and I have indicated our willingness to give presentations and other volunteers are welcomed. There is still time to contact Roy or

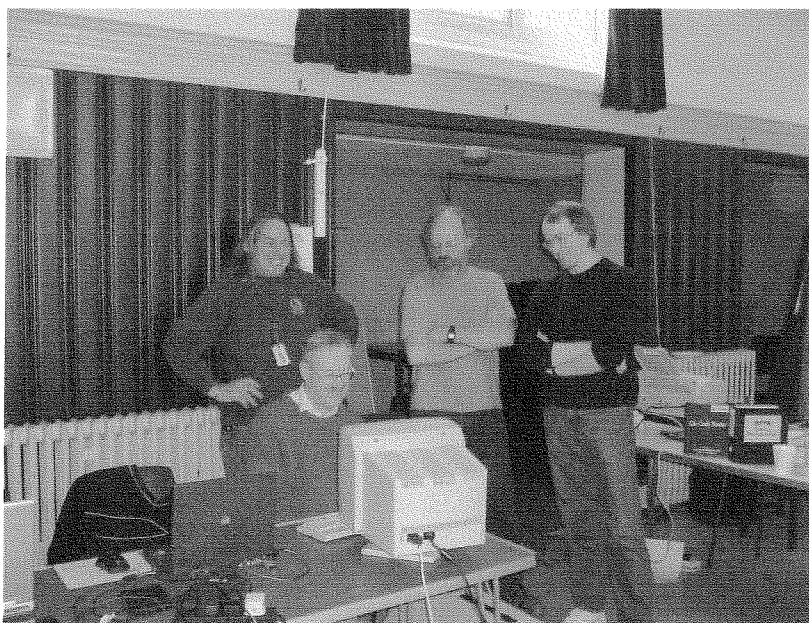

Quanta with any wishes or ideas for the weekend.

This will almost certainly be the only UK show in 2007.

**Bob Spelten jr writes:**

In his review of Pal Monstad's Doc Viewer (QLT v11i2) David Denham was disappointed that the program doesn't accept a filename to be passed in the EX command to make it work with FileInfo2. But one of the great points about FI2 is that it can be configured to make it work even in this case. All you need to do is construct a Command line that FI2 will pass to the executing job.

I use the following line with success for years now with Doc Viewer.

```
"V<pause 1s><F3><pause 1s><devN_name_ext>  
<ENTER><pause 1s>W<pause 1s><CTRL F2>".
```

The "V" opens the File\_Select window, F3 picks the filename sub window, the filename is inserted and Enter pressed which opens the file in the viewer. The "W" sets Wrap On and Ctrl F2 refreshes the viewer window. The pauses are there to give the program time to execute the command and these values work fine on my Aurora/SGC but could be made longer for slower systems or maybe omitted on faster ones, just try it out.

Also check out the sample file FileInfo2\_bin, this holds a command string to load a document in Xchange and this is further explained in the manual. The trick is to write down all the key presses an application needs to open a file and input these in the command string editor of FI2. Add some pauses where needed. You can make almost any program open with a file this way by DOing the filename. It works for me with Text87 (\_T91, \_txt or \_doc) or Xchange (\_doc, \_aba \_dbf, \_prg or \_tsl). There was a review of FileInfo2 by Roy Wood in QLT v4i5.

**George Gwilt writes:**

## Comments on Programming in Assembler – Part 15

by Norman Dunbar (QL Today Vol 11 issue 2)

How nice that Norman Dunbar has turned his attention to the Maths Package in QDOS. This has always struck me as a powerful tool. To be able to perform many arithmetical steps with one call to the operating system is useful indeed. You can of course use this facility inside a stand alone assembler program, or as a routine to be CALLED

by a S\*BASIC instruction, but Norman has opted instead to show it working in a keyword. I have only one comment on ROOT. It is that, as explained by Dickens (QL Advanced User Guide), you do not need to test D0 for errors after a call to a vector since the condition codes are set on return. Indeed Norman does not make the test after calling the vector BP\_INIT near the top of page 21. The two later tests on that page can thus be deleted.

ANYROOT is more interesting as it uses RI\_EXECB to perform a string of operations. Once again the testing of D0 in do\_it and do\_more is not really needed. Also, I should point out that the three lines of op\_codes should not be between got\_ok and do\_it otherwise do\_it will never be done. Also I wonder how Norman expects it to work given that the address in A3, set in do\_more, is not relative to A6 as he suggests is necessary in his definition of RI\_EXECB on page 26. (But see later.)

It is annoying that immediately after the first operation the operands are in the wrong order on the stack. Norman has produced swap\_tos to switch the order. The code works well, but, since I started my programming life on machines with limited space and slow speed, I always try to compress and speed up any program. I might suggest here that you eliminate the two occurrences of "exg d6,d7" and instead swap the d7 and d6 in the following two lines in both cases.

I have, however, a more radical suggestion. It is that you eliminate both do\_it and swap\_tos and increase the size of op\_codes so that the whole procedure is carried out with just one set of operations using RI\_EXECB. The easy way of doing this is possible if you have SMSQ or Minerva both of which have additional operations one of which swaps TOS and NOS. The code is \$17. The second method is to go through the business of copying TOS and NOS somewhere and then returning them to NOS and TOS. The codes for this are in the group referred to by Norman as \$FF31 to \$FFFF. The place I would use for temporary storage is the Basic buffer. First, op\_codes would become:

op\_codes dc.b      ri\_ln,-5,-11,-6,-12,ri\_div,ri\_exp,ri\_end

do\_it and swap\_tos would be deleted and do\_more would have added to it:

```
movea.l    bv_bfbas(a6),a4
lea        12(a4),a4            point to the end of 12 bytes
```

If you really think that there may not be as much as 12 bytes available in the Basic buffer you can add:

```
cmpa.l    bv_tkbas(a6),a4      is A4 beyond the end of the buffer?
bhi        bufful                oops
```

bv\_bfbas is 0 and bv\_tkbas is 8.

The codes -5 and -6 save and load 6 bytes to and from -6(A6,A4.L) and the codes -11 and -12 do the same with address -12(A6,A4.L).

Apart from pointing out the obvious need to resite the op\_codes section so that Norman's program works, so far I have done no more than suggest other ways of writing a program already viable. However, I do have severe objections to the later part of the article. This mainly relates to the op codes, especially those used for loading and saving numbers onto and from the stack. The table at the top of page 26 lists the op codes. If used in RILEXECB these must fit into bytes. It is thus plain wrong to list the codes other than those from 0 to \$30 as \$FF31-\$FFFF. But why should Norman do this? To find out I examined the definitions of RILEXEC/B in five different publications:

<u>Title</u>	<u>Author</u>	<u>Errors</u>
QL Technical Guide	David Karlin & Tony Tebby	A and B
QL ADVANCED USER GUIDE	Adrian Dickens	C
QL ASSEMBLY LANGUAGE PROGRAMMING	Colin Opie	D
The Sinclair QDS Companion	Andrew Pennell	none
QDOS Reference Manual	Jochen Merz	A

What I found was surprising.

Only Pennell gives enough correct information for a programmer. All the others give seriously wrong information. The worst of these is the first publication and it is this one Norman appears to have relied on for his article.

The errors A to D are:

A Implying that operation codes beyond \$30 are \$FF31 to \$FFFF

B Saying that the address in A3 (RILEXECB) is relative to A6.

C Slightly wrong definition of the address produced by codes \$31 to \$FF

D D0.B instead of D0W (RILEXEC)

Having made such a damning assertion I must explain further. The QL Technical Guide is perhaps obscure rather than wrong in containing error B.

The obscurity starts with the sentence:

"The interpreter takes two types of operation codes." What this in fact means is that the interpreter code takes and uses a modified form of the operation code bytes.

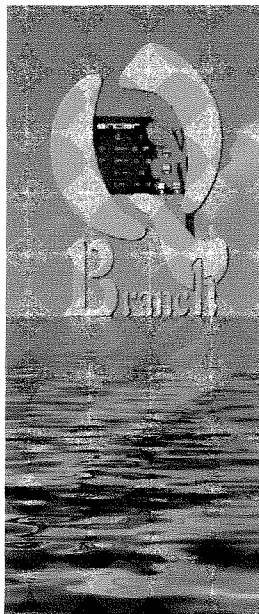

Feeling out on a Limb?  
Reach out for QBranch  
Suppliers of Quality QDOS/SMSQ products  
Hardware and Software

20 Locks Hill  
Portslade  
Sussex  
BN41 2LB  
UK

Tel: +44(0)1273 386030  
Fax: +44(0)1273 430501  
Mobile: +44(0)7836 745501

email : sales@qbranch.demon.co.uk  
www.qbranch.demon.co.uk

We can accept payment by  
Visa, Mastercard, Maestro and  
Switch. We also accept sterling  
cheques drawn on a UK bank  
or payment direct to our bank:

Natwest

Sort code 60-17-01

Acc. 84534826

BIC : NWBKGB 2L

IBAN :

GB34 NWBK 6017 0184 5348

26



## QDT

The Ultimate QL Desktop

v1.02

**£41.50** + p&p

£2.00 UK / 2.50 EU / £ 3.00 RoW

Needs SMSQ/E & extended  
colours to run

## EasyPTR v4

Pts 1&2

Major Rewrite!

**£42.00**

Produce High Colour  
pointer-driven menus from  
SuperBASIC

Also on  
CD Rom

## Text 87 £ 79.00

High Colour Patch (all systems) £9.00

ESC/P2 drivers £ 26.00 / Fountext £39.00

Typset94 / 2488 drivers £29.00 ea.

## SMSQ/E and QPC 2

SMSQ/E for Gold Card / Atari / QXL / Q40

Aurora High Colour Driver included with  
Gold Card Version

**£ 27.00**

QPC 2 v 3.33

Now only **£ 42.00**

Upgrade Prices:

from v 3.xx Free

from v 2.xx £13.90

from v 1.xx £34.00

Delivered on CD ROM  
with Manual as Adobe  
Acrobat File

## QPCPrint

Print to any Windows Installed Printer from  
Your QL Programs !

**£27.00**

## Programs upgraded to high colour version

QMake / WinEd / QPAC 1 / QPAC 2 / QSUP / SuQcess / Disk Mate 5

Send old master disk and £1.60 per disk to cover costs

Paid Upgrades

QD 98 to QD 2003

£10.50

QSpread 2001 to QSpread 2003

£10.50

Return Master Disk  
with order

Free!



All the keyboard membranes have now gone but, if you still need one. Contact Rich Mellor of RWAP.

A New Version of QPC2 which will run under the new Windows Vista Operating System will be released shortly.  
(Microsoft broke it not Marcel)

See you all at the Hove Workshop and Quanta AGM in April.

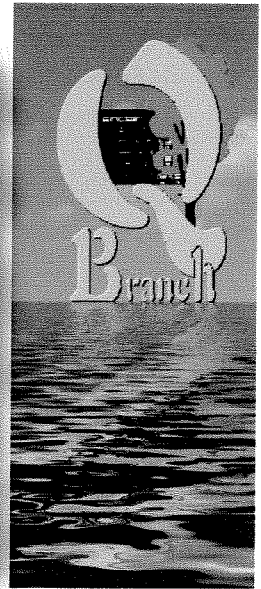

Utilities		Programs		Programming	
Fifi2	File Finder	£21.00	QD 2003	Text Editor & More	£ 49.00
QSup	Utillies	£30.00	QBASIC	QLiberater to QD Link	£ 15.00
QSpread	Spreadsheet	£51.00	QLiberator	Basic Compiler	£ 50.00
Cueshell 2	File Manager	£15.00	QD + QBASIC		£ 63.00
QPAC 2	File Manager & Utilities Package	£42.00	QD + QBASIC + QLiberator		£104.00
QPAC 1	Calendar, Clock, Calculator, Sysmon	£22.00	QPTR	Pointer Toolkit	£ 32.00
QLoad/Qref	Fast load for QDOS	£15.00	MasterSpy	Fast Text Editor	£ 30.00
QTYP2	Spell Checker	£31.00	QMake	Assembler Tools	£ 18.00
QLQ	Printer Utility	£30.00	QMon/Jmon	Monitor - Upgrade only	£ 22.00
SuQcess	Database	£28.00	BASIC Linker	Basic Library Linker	£ 22.00
Q-Route	Route Finder	£25.00	Disa 3	Dissassembler	£ 34.00
Knight Safe3	Backup Program	£35.00	QMenu	Menu Extensions & tutorial	£ 16.00
Fractal Collection	Fractals	£35.00	Easyptr v4	Toolkits & Programming Extns	£ 41.50
QCount	Accounting	£25.00	Easyptr v4	Part 3 C extensions	£ 14.00

## HARDWARE

We have a rotating stock of both new and second user hardware. It is best to call or email us for details of what is available.

### Recycled Items (when available)

Super Gold Card	£110.00
Gold Card	£ 45.00
Aurora	£ 65.00
QXL	£ 35.00
superHermes	£ 65.00
DiRen Keyboard	
Interface	£ 15.00
Qplane	£ 5.00

### New Items

Aurora	£70.00
Aurora w/8301 & Minerva	£80.00
8mb Rom Disq	£98.00
4mb Rom Disq	£65.00
2mb RomDisq	£39.00
mPlane	£34.00
MCplate	£ 6.50
Various braQuets	£ 8.00
Gold /Super Gold Card Batteries	£10,00

We also have a collection of standard QLs, QL Power supplies and some QL books.

Cables for the Aurora, Qubide and Super Gold Card ROMs and other QL accessories are also available from us.

Call for details

The reason why "interpreter" is mentioned is that the routines are part of the BASIC package inside the QDOS operating system. These are made available by vectors. This means that their definition is not a specification of what the code for the routines must do but a description of the code already written to which we are given access. To understand better what Karlin and Tebby intended one has to look at the program being described.

Here then is the relevant code (from the JS rom):

```

RI_EXEC  MOVEM.L   D1-3/A0/A2-3/A5,-(A7)
          SUBA.L   A5,A5
          BRA.S   L041C0

RI_EXECB MOVEM.L   D1-3/A0/A2-3/A5,-(A7)
          MOVEA.L  A3,A5                    address of op_codes
L041BA   MOVEQ    #0,D0
          MOVE.B   (A5)+,D0                D0.L contains the op byte
          BEQ.S    L041F8                    end of op_codes
L041C0   CMPI.B   #$30,D0
          BHI.S    L041CC                    codes $31 to $FF
          BSR.S    L041FE                    codes $01 to $30

```

.....

```
L041CC  ORI.W    $FF00,D0
```

; This changes the contents of D0.W from \$xx31 - \$xxFF to \$FF31 - \$FFFF. That  
; means that the upper byte of D0.W is irrelevant for codes \$31 to \$FF.

```

          BCLR    #0,D0                    is it save or load?
          ADDA.W  D0,A4                    reduce A4 by a number between
                                          206 and 2

```

.....

```

L041FE  MOVE.W   L04204(D0.W),D0
          JMP    L04296(D0.W)

```

; This piece of code jumps to the appropriate program for the operations \$02 to  
; \$30. As you can see it is necessary that the upper byte of D0.W as presented  
; to RI\_EXEC should be zero.

.....

What Karlin and Tebby say next is:

"The first [type of operation code taken by the interpreter] is a true arithmetic operation with operation code between \$02 and \$30 inclusive, the second is a negative code between \$FFFF and \$FF31 inclusive .."

You can see that at L041CC the byte operation code in D0.B, which is between \$31 and \$FF is used to produce the negative word \$FF31 to \$FFFF in D0.W. The reason for giving a potential programmer this information is not to tell him how to present the op code to the routines in the first place but to tell him how that code (\$31 to \$FF) translates to an address offset. You will see that the instructions just after L041CC lop off the last bit of D0 and then add the result (sign extended to a full word) to A4.

It would have been better if Karlin and Tebby had incorporated in their Technical Guide the information in the answers below. Only Pennell gives information in this form and so is much to be preferred to the others.

What a programmer wants to know is:

1. What the op codes are

**Answer** – op codes 2 to 48 (\$02 to \$30) do arithmetical operations  
– op codes 49 to 255 do (\$31 to \$FF) load and save

2. How to set the op codes

**Answer** – for RI\_EXEC set the op code value (2 to 255) in D0W  
– for RI\_EXECB set the op codes in a list of bytes ending with 0

3. What the op codes do

**Answer** – see the table for codes 2 to 48  
– for codes 50 to 254 (even values) load from (op code-256)(A6,A4.L)  
– for codes 49 to 255 (odd values) save to (op code-257)(A6,A4.L)

Now let's see how SMSQE v3.13 does it.

```
RI_EXECB
    move.l  a3,-(sp)
    moveq   #0,d0
    bra.s   qam_eloop
qam_loop
    bsr.s   RI_EXEC
    bne.s   qam_exit
qam_eloop
    move.b  (a3)+,d0
    bne.s   qam_loop
.....

RI_EXEC
    cmpi.b  #$32,d0           ; operation?
    bhi.s   qao_ldst         ; ... no
    ext.w   d0
    add.w   d0,d0
    add.w   qao_tab(pc,d0.w),d0
    jmp     qao_tab(pc,d0.w) ; ... do it

qao_ldst
    ori.w   #$ff00,d0        ; always negative
    belr   #0,d0            ; load or save
    beq.s   qao_load
    move.w  (a1)+,(a4,d0.w)
    move.l  (a1)+,2(a4,d0.w) ; save
.....
```

As you can see here, the operations to save and load numbers rely only on D0.B in the same way as for the JS rom (as stated in Pennell). However, the op\_codes \$02 to \$32 can also be presented to RI\_EXEC as only a byte. SMSQE is rather more relaxed than QDOS.

Having explained how the operations codes are used by RI\_EXEC and RI\_EXECB I return to Norman's article on page 26.

1. In the description of the OpCodes he lists \$FF31 to \$FFFF as the 'save' and 'load' bytes. Clearly these should be \$31 to \$FF (or 49 to 255).

2. In the definition of RLEXEC it is bits 8 to 15 of D0 which should be zero and not the high word, which can in fact be anything.

3. In the definition of RLEXECB A3.L is the absolute pointer to the list of op codes. It is not relative to A6 as stated. (So ANYROOT will work after all.)

4. There are various things to say about page 27.

4.1 The byte op codes from \$33 to \$FF can be used to save and load numbers. The effect of codes \$31 and \$32 depend on the operating system. JS rom and SMSQ differ here. Both operating systems contain oddities. In the JS rom \$31 will be treated as a save to -208(A4,A6.L). However, \$30 will be treated as the operation NOS^TOS so that you can't bring back the saved item!

SMSQE has a different, though similar quirk. The code \$31 gives a "not implemented" error. Code \$32 puts PI on the stack. Code \$33 saves the number on the stack to -206(A4,A6.L). As with the JS rom this number cannot be reloaded, since the code to do so just puts PI on the stack!

4.2 Norman mentions calling "this routine with \$FF33". This is of course impossible with RLEXECB, the op code is just \$33. You can call RLEXEC with DOW equal to \$FF33, or \$1C33, or \$0033 and each will have the same effect. He then says that the actual address used for

storage is:

$A6.L + A4.L + (D0.W \text{ AND } \$FFFE)$

Again, I'm afraid this is not quite true. The address is actually:

$((\text{op code AND } 254) - 256)(A4, A6.L)$

4.3 Pennell is not wrong in the way Norman suggests in his first WARNING on page 28. First, as I have tried to explain, the op codes are really and truly byte sized numbers (2 to 255). Second, Pennell gives the range for loading (not saving) a number. His range of offsets, -206 to -2 is absolutely correct for QDOS. It is when Pennell says that the op codes with odd values \$31 to \$FF give the same range he is wrong. That range is -208 to -2, but the value -208 is effectively useless. I don't think this very minor error will bother anyone and it certainly does not warrant a WARNING.

4.4 Norman suggests that in fact you can use a byte for the codes \$31 to \$FF when using RLEXEC, but that it is an undocumented feature. This is not true since Pennell (page 133) does document it.

4.5 I would like to add real WARNING. It is that you can crash the program by using an odd op code below 50 in QDOS. This is because the code is used directly as an index into the programs performing the operations.

I hope Norman will forgive me for attempting to set so many things straight. The errors are not wholly his fault!

## Programming in Assembler -

### Part 17 - or not Part 17!

by Norman Dunbar

George Gwilt, my faithful reader, has brought me to task on my last two articles. Part 15 where I wrote (ok, updated a very old 1991 utility which I had written) and again after Part 16 where I delved into the Arithmetic Package in QDOSMSQ.

I shall attempt to answer Georges concerns in this article.

## Part 15 – Dataspace Utility

George makes a number of interesting points about this article and all I can say is, 'he is absolutely correct'.

As for my small routine to convert an ASCII string into a number in a long word, George asks why it is not itself a sub-routine when I make such a 'fuss' (my word) of reusable code.

I can only plead guilty as charged and state, for the record, that this is the only time I've ever written anything in assembly language which required me to do that conversion. To that end, and nothing else, the code was in-lined in 1991 and remained so in 2006.

However, I'm sure a general purpose ASCII→Long could be easily written as a subroutine. I'm certain that there is one lurking somewhere inside QDOSMSQ which correctly (I hope) handles invalid characters, errors, overflow and so on.

I shall be creating just such a beast in my next (exciting) article. Watch this space.

I feel rather unable to comment on George's own conversion routine – I never did very well at maths at school and I'm not sure exactly how George's code works (yet!).

## Part 16 – Arithmetic Package

Shortly after that article appeared, George contacted me with a whole host of problems – details of which, I believe, appear elsewhere in this issue.

I shall attempt to answer George's concerns below, although George and I have conversed in an email exchange on this subject, I think it is proper to publicise the results especially as they concern my previous article.

Corrections are due! George's concerns and

---

```
got_ok      cmpi.w  #2,d3          ; Make sure we only got one parameter
            bne.s  bad_param      ; Oops !
            bra.s  do_it           ; skip over the op-codes.
```

With a short branch over the op-codes added. I suspect that I have inadvertently fixed the code while running under QPC but forgotten to save the corrected version back to one of my DOS\_ drives prior to importing the code into the article. Quite honestly, the original code without the branch would most likely have hung the system.

I have checked my source code system and found that the same 'broken' version is present there too, so it does look like I forgot to save a

comments are prefixed <GEORGE> and my replies follow on prefixed by <NORMAN>

<GEORGE> ... I have only one comment on ROOT. It is that, as explained by Dickens (QL Avanced User Guide), you do not need to test D0 for errors after a call to a vector since the condition codes are set on return. Indeed Norman does not make the test after calling the vector BP\_INIT near the top of page 21.

The two later tests on that page can thus be deleted.

<NORMAN> I agree, however, it has been my observation in the past that only sometimes are the condition codes actually set on exit from QDOSMSQ. To this end I tend to always test D0 on exit from a QDOSMSQ call – just to be safe. This does mean that where I neglected to do this after the call to BP\_INIT (on page 21) is where \*my\* error was. I should have had a test there. George points out that I don't need the two tests later on that same page. While technically correct, I would be inclined to leave them present and add in the one I missed out rather than removing the latter two. I like to make sure that the condition codes are correctly set by testing them explicitly as this saves me trying to remember which calls do set them and which calls don't.

<GEORGE> ANYROOT is more interesting as it uses RI\_EXECB to perform a string of operations. Once again the testing of D0 in do\_it and do\_more is not really needed. Also, I should point out that the three lines of op\_codes should not be between got\_ok and do\_it otherwise do\_it will never be done.

<NORMAN> This is absolutely correct. I have no idea what went on here, but the code should be as follows:

change back to DOS. 'Mea Culpa' as they say.

<GEORGE> Also I wonder how Norman expects it to work given that the address in A3, set in do\_more, is not relative to A6 as he suggests is necessary in his definition of RI\_EXECB on page 26. (But see later.)

<NORMAN> I'm afraid that this was a 'cut and paste' error. I copied the A1 line above it and

pasted it in. While I remembered to change the A1 to an A3, I neglected to remove the part about it being relative to A6. That is incorrect as A3.L is the pointer to the string of bytes and is not relative to A6 at all.

«**GEORGE**» It is annoying that immediately after the first operation the operands are in the wrong order on the stack. Norman has produced swap\_tos to switch the order. The code works well, but, since I started my programming life on machines with limited space and slow speed, I

always try to compress and speed up any program. I might suggest here that you eliminate the two occurrences of "exg d6,d7" and instead swap the d7 and d6 in the following two lines in both cases.

«**NORMAN**» I started on a ZX-81 with 1KB of RAM and I'm mostly self-taught - hence all the errors!

George suggests changing my code at SWAP\_TOS from this:

```
swap_tos    move.l    0(a6,a1.1),d7      ; Get a long word
            move.l    6(a6,a1.1),d6      ; And another
            exg       d6,d7              ; Swap them around
            move.l    d7,0(a6,a1.1)     ; Store
            move.l    d6,6(a6,a1.1)     ; Store
            move.w    4(a6,a1.1),d7
            move.w    10(a6,a1.1),d6
            exg       d6,d7              ; Swap again
            move.w    d7,4(a6,a1.1)
            move.w    d6,10(a6,a1.1)    ; Now we have N and LN(M) swapped
```

to the following to save a couple of instructions and hence, valuable time and space:

```
swap_tos    move.l    0(a6,a1.1),d7      ; Get a long word
            move.l    6(a6,a1.1),d6      ; And another
            move.l    d6,0(a6,a1.1)     ; Store
            move.l    d7,6(a6,a1.1)     ; Store
            move.w    4(a6,a1.1),d7
            move.w    10(a6,a1.1),d6
            move.w    d6,4(a6,a1.1)
            move.w    d7,10(a6,a1.1)    ; Now we have N and LN(M) swapped
```

Once again, George is correct - I must have run out of caffeine at that point. The two EXG instructions are completely un-necessary when written as above.

«**GEORGE**» I have, however, a more radical suggestion. It is that you eliminate both do\_it and swap\_tos and increase the size of op\_codes so that the whole procedure is carried out with just one set of operations using RI\_EXECB. The easy way of doing this is possible if you have SMSQ or Minerva both of which have additional operations one of which swaps TOS and NOS. The code is \$17.

«**NORMAN**» I try to keep things as close to the original QL as possible so this option may not have been available to some of my other readers. I was, however, completely unaware of it until George sent me his email. I am completely

surprised in finding myself to be the first person since QDOS was originally written to need a SWAP\_TOS\_NOS routine :o)

When I wrote the code originally, I was almost certain that I could do it an one single RI\_EXECB operation. That was when I discovered the need for a swap operation and hence the break up into a single RI\_EXEC, manual swap and the RI\_EXECB call. Not as elegant as I would have liked.

«**GEORGE**» The second method is to go through the business of copying TOS and NOS somewhere and then returning them to NOS and TOS. The codes for this are in the group referred to by Norman as \$FF31 to \$FFFF. The place I would use for temporary storage is the Basic buffer. First, op\_codes would become:

# RWAP Services NEWS!

We have moved back to Walsall for the time being - see our current address at the bottom of the page.

Better news is that we now have an extended range of second hand items for the Sinclair QL and ZX Spectrum, and have one remaining Epson 850 Inkjet printer available. Z88 stocks are however now getting quite low so if there is anything you need, please browse our website:

<http://www.rwapsoftware.co.uk>

We are also looking to produce some new hard disk interfaces for the ZX Spectrum and have a few little projects on the drawing board.

Our websites:

<http://www.rwapsoftware.co.uk> (General site)  
<http://www.rwapsoftware.co.uk> (Sinclair computer second hand and new items)  
<http://www.rwapadventures.com> (Adventure Programs)  
<http://www.internetbusinessangels.com> (Guidance on setting up online businesses).

## New Products!

### QWORD 1.0 NOW WITH DIGITAL SOUND ON QPC2!

The wait is now over! Q-Word version 1 is finally available!

Platforms:

QPC/QXL, Q40/Q60, Aurora (with SGC)

Prices:

All versions without P-Word £20.00  
 All versions with P-Word £30.00

Notes:

Q-Word DOES NOT require SMSQ/E with GD2 support -OR- SMSQ/E at all on the Aurora or Qx0 machines. It works on the highest colour depth everywhere regardless of Operating System.

The Aurora version is available on either HD or ED disk. For the latter add £1.00 to the price. ED version is uncompressed and can be run directly from the floppy. All other Floppy versions are compressed. QPC/QXL version comes on CD. Non CD versions DO NOW support digital sound on QPC2

## Quantum Leap ED Drives

The bad news is that our stock of ED Disk Drives has now been depleted and there is no sign of any more being available in the short term.

We do however have a range of brand new DD and ED 3.5" Diskettes for sale at low prices:

10 x 3.5" DSDD Disks £7.50  
 10 x 3.5" ED Diskettes £10  
 10 x 3" Disks £9

Prices do not include post and packing - please ask us for details.

We do have a range of second hand disk interfaces and drives (one or two ED Drives) for use with the Sinclair QL, so if you need anything, please let ask.



for Windows

For QLers that run Windows or with incompatible hardware for Talent Games, we now have re-released these adventures so that they can run on your Windows-equipped PC. No Emulator, floppies, microdrive backups etc. required, just a one-click install! Of course the full QL line is still available! (See side column)

Talent Games for Windows ea. £ 10.00  
 (Each Game includes a runtime installation of QLAY-2 by Jimmy Montesinos)

## RWAP Services

26 Oak Road, Sheffield, Walsall, West Midlands WS4 1RQ TEL: +44 1922 691607 From the UK Dial: 01922 691607  
 Website: <http://www.rwapsoftware.co.uk>  
 Email: [sales@rwapsoftware.co.uk](mailto:sales@rwapsoftware.co.uk)

We Accept Payment using:



(Cheques in £ sterling made payable to R. Mellor)

## Old Favourites!

### Utilities

SBASIC / SuperBASIC Reference Manual on CD	£ 20.00
Sidewriter v1.08	£ 10.00
Landscape Printing (EPSON printers)	
ImageD v1.03	£ 10.00
3D object generator	
Q-Help v1.06	£ 10.00
Superbasic On-Screen help system	
Q-Index v1.05	£ 5.00
Keyword-to-topic finder	
ProForma ESC/P2 Drivers v1.04 for ProWeSs Printer Driver	£ 8.00

### Applications

Flashback SE v2.03 (upgrade only)	£ 5.00
Database	
QL Cash Trader v3.7	£ 5.00
Accounting/Finance	
QL Payroll v3.5	£ 5.00
Accounting/Finance	
QL Genealogist v3.26	£ 20.00
Genealogy	
Genealogy for Windows	£ 50.00
QL Genealogist to Windows version upgrade	£ 25.00
QL Cosmos v2.04	£ 5.00
Planetarium	
Q-Route v2.00	£ 25.00
Route Finding	
Upgrade from v1.xx	£ 5.00
Britain map v1.11	£ 2.00
BIG Britain map (needs 2Mb) v2.03	£ 5.00
Various Britain Area maps (ask for details)	ea. £ 2.00
Ireland map v1.00	£ 5.00
Belgium map v1.01	£ 2.00
Catalonia map v1.03	£ 2.00
P-Word UK English Dictionary (500.000 words!) Dictionary	£ 15.00

### Leisure

Return to Eden v3.08	£ 10.00
Adventure	
Nemesis MkII v2.03	£ 8.00
Adventure	
The Prawn v2.01	£ 8.00
Adventure	
Horrorday v3.1	£ 8.00
Adventure	
West v2.00	£ 5.00
Adventure	
The Lost Kingdom of Zkul v2.01	£ 5.00
Adventure	
All 6 games above	£ 25.00
D-Day MkII v3.04	£ 10.00
Strategy/War Simulation	
Grey Wolf v1.08	£ 8.00
Graphical Submarine Simulation	
War in the East MkII v1.24 (upgrade only)	£ 5.00
Strategy/War Simulation	
Open Golf v5.20	£ 8.00
Sports Simulation	
QuizMaster II v2.07	£ 5.00
Quiz	
Stone Raider II v2.00	£ 5.00
Arcade Game	
Hoverzone v1.2	£ 5.00
Arcade Game	
Deathstrike v1.5	£ 5.00
Arcade Game	
Flightdeck v1.0	£ 10.00
Flight Simulation	
All 6 games above (Open Golf, QuizMaster II, Stone Raider II, Hoverzone, Deathstrike and Flightdeck)	£ 28.00

### Notes on Software requirements

The following programs have a minimum SGC card requirement: P-Word, Qword, Big Britain MAP for Q-Route

op\_codes dc.b ri\_ln,-5,-11,-6,-12,ri\_div,ri\_exp,ri\_end

do\_it and swap\_tos would be deleted and do\_more would have added to it:

```
movea.l    bv_bfbas(a6),a4
lea        12(a4),a4           point to the end of 12 bytes
```

If you really think that there may not be as much as 12 bytes available in the Basic buffer you can add:

```
cmpa.l    bv_tkbas(a6),a4     is A4 beyond the end of the buffer?
bhi       bufful             oops
```

bv\_bfbas is 0 and bv\_tkbas is 8.

The codes -5 and -6 save and load 6 bytes to and from -6(A6,A4.L) and the codes -11 and -12 do the same with address -12(A6,A4.L).

«**NORMAN**» Again, when I wrote the article, I was having a few difficulties with the save and load op-codes and was enjoying much discussion on the QL-USERS email list at the time. I avoided them until I could better understand them. As it turned out, the explanations simply confused the matter (for me) and I decided to leave them alone and simply document them at the end of my article.

Interstingly, George raises something that I was always confused by when Simon N Goodwin was writing in the old QL World assembly language series, using the Basic Buffer as a workspace. I'm sure that there could be a couple of pages for an article here on this very subject - if someone who knows it was prepared to write one (hint hint). :o)

«**GEORGE**» ... However, I do have severe objections to the later part of the article. This mainly relates to the op codes, especially those used for loading and saving numbers onto and from the stack. The table at the top of page 26 lists the op codes. If used in RILEXECB these must fit into bytes. It is thus plain wrong to list the codes other than those from 0 to \$30 as \$FF31-\$FFFF. But why should Norman do this?

«**NORMAN**» To answer the last question, I did it because I was advised by Marcel Kilgus, in an email, that I differed from the documentation and that the load and save op-codes were indeed negative words and not bytes. And indeed, I quote:

"... the opcodes \$FF31 to \$FFFF are for load/save, not \$32 to \$FF. Yes, the latter DO work, but it seems that's more an undocumented side-effect."

I took the advice of the man who wrote QPC and probably has forgotten more about Assembly Language programming that I have ever known!

«**GEORGE**» To find out I examined the definitions of RILEXEC/B in five different publications...

«**NORMAN**» In order to reduce the amount of duplication in this issue, I have snipped Georges main explanation below - you can (hopefully) read it elsewhere.

George has given a pretty thorough explanation of the differences between the above 5 sets of documentation and the code in a JS ROM and SMSQ/E - I can only state that I wish I had stuck with Pennell rather than trying to find out more!

I now skip directly to George's closing points.

«**GEORGE**» ... Having explained how the operations codes are used by RILEXEC and RILEXECB I return to Norman's article on page 26.

1. In the description of the OpCodes he lists \$FF31 to \$FFFF as the 'save' and 'load' bytes. Clearly these should be \$31 to \$FF (or 49 to 255).

«**NORMAN**» This is correct. Obviously, had I been paying more attention in class, I would have questioned Marcel's WORD information as the RILEXECB call executes a string of BYTES. Setting a WORD in amongst the bytes would have resulted in an \$FF op-code being carried out followed by a separate and incorrect byte code, rather than a store or load operation.

Basically, when I say 'a negative word' I really mean 'a negative byte'.



«GEORGE» 2. In the definition of RILEXEC it is bits 8 to 15 of D0 which should be zero and not the high word, which can in fact be anything.

«NORMAN» Correct. RILEXEC expects a byte sized op-code.

«GEORGE» 3. In the definition of RILEXECB A3.L is the absolute pointer to the list of op codes. It is not relative to A6 as stated. (So ANYROOT will work after all.)

«NORMAN» Yes, as admitted above, this was a type on my part. A3.L is an non-relative address.

«GEORGE» 4.1 The byte op codes from \$33 to \$FF can be used to save and load numbers. The effect of codes \$31 and \$32 depend on the operating system. JS rom and SMSQ differ here. Both operating systems contain oddities. In the JS rom \$ 31 will be treated as a save to -208(A4,A6.L). However, \$30 will be treated as the operation NOS^TOS so that you can't bring back the saved item!

SMSQE has a different, though similar quirk. The code \$31 gives a "not implemented" error. Code \$32 puts PI on the stack. Code \$33 saves the number on the stack to -206(A4,A6.L). As with the JS rom this number cannot be reloaded, since the code to do so just puts PI on the stack!

4.2 Norman mentions calling "this routine with \$FF33". This is of course impossible with RILEXECB, the op code is just \$33. You can call RILEXEC with D0.

W equal to \$FF33, or \$1C33, or \$0033 and each will have the same effect. He then says that the actual address used for storage is:

$$A6.L + A4.L + (D0.W \text{ AND } \$FFFE)$$

Again, I'm afraid this is not quite true. The address is actually:

$$((\text{op code AND } 254) - 256)(A4, A6.L)$$

«NORMAN» I agree with George's point 4.1. As for 4.2, the address calculation I gave is the one I found in Jochen's QDOS Documentation.

«GEORGE» 4.3 Pennell is not wrong in the way Norman suggests in his first WARNING on page 28. First, as I have tried to explain, the op codes are really and truly byte sized numbers (2 to 255).

Second, Pennell gives the range for loading (not saving) a number. His range of offsets, -206 to -2 is absolutely correct for QDOS. It is when Pennell says that the op codes with odd values \$31 to \$FF give the same range he is wrong. That range is -208 to -2, but the value -208 is effectively useless. I don't think this very minor error will bother anyone and it certainly does not warrant a WARNING.

«NORMAN» I'm not doing very well am I? Once again, I stand corrected.

«GEORGE» 4.4 Norman suggests that in fact you can use a byte for the codes \$31 to \$FF when using RILEXEC, but that it is an undocumented feature. This is not true since Pennell (page 133) does document it.

«NORMAN» I blame Marcel, it's all his fault. (Only kidding.) As I mentioned above, I was basing my article on the latest information that I had been given as a result of asking for clarification on the QL-USERS mailing list.

«GEORGE» 4.5 I would like to add real WARNING. It is that you can crash the program by using an odd op code below 50 in QDOS. This is because the code is used directly as an index into the programs performing the operations.

«NORMAN» This is indeed true.

«GEORGE» I hope Norman will forgive me for attempting to set so many things straight. The errors are not wholly his fault!

«NORMAN» Phew, I'm glad that's over. I took a severe beating at the hands of George and I promise to do better in future!

Seriously, I'm always happy to be corrected in anything I say or write - so, if you spot anything that you disagree with, let me know.

And as for forgiveness, I have no problems there either.

So, that's a slightly different article this time. I hope to be back in deepest, darkest code again next time, especially as I have promised to provide a useful ASCII to long word conversion routine. I think I know just where I can find one....

# Minimalist 3D Animation

by Stephen Poole

In recent editions I have printed some quite long programs, which, although they may be satisfying when finalised, do not give the same buzz to other users as when short, condensed routines do a lot with little code. (As well as the fact that short routines require very little typing-in and as such are accessible to more readers).

It is amazing the number of programs that contain but one REPEAT loop containing two nested FOR loops. They can, and do, do just about everything you can imagine. This is because the number of combinations achievable by such nested loops is virtually infinite. That is why so much code looks the same and requires careful reading to make sense of. So with so much theoretic potential available you have no excuse for not exercising your full creative talents on the QL!

For this Issue, I thought I would do a routine to give a pseudo-3D animation of a moving, morphing Tetrahedron, using minimalist code. Why a Tetrahedron? Because it is the simplest solid shape. Simple code generally means efficient, that is, fast routines, which are of course essential for animations. This program was written on a 'JS' SuperGoldCard with SMSQ/E, but will run happily on a standard QL or QPC.

I have compressed real 3D perspective programs to fit onto 20 (#2) 'wide-screen' program lines, but this tends to make them unreadable as their structure is spread around higgledy-piggledy, and once unthreaded, they may easily occupy sixty or more lines.

Recursive routines tend to be the most compact, as all the complicated stacking and returning is done implicitly by the processor, which could therefore be thought of as 'cheating' compared to normal 'iterative' code, which must be fully defined by the programmer.

When I first bought my QL in 1984, I used a similar 'Tetrahedron' routine to impress friends with the QL's graphics capabilities which were, at the time, pretty good compared to the 'IBM PC'.

This program could be used with the Cueshell 'CUEDARK' screen-saver module if you wish. Try modifying the code from Lines 240 to 260 to draw cubes or other shapes, as you can easily condense such code for regular right-angled solids using the short form of one-line loops.

```
100 REMark Tetrahedron_bas. by S.Poole, v10jun2005
110 REMark Hit any key if off-screen, or 'q' to Quit.
120 CLEAR: OPEN#1,con_16: i$=''
130 :
140 DIM T(0): WINDOW 512,256,0,0: IF CODE(i$)=27: OVER 0: STOP
150 SCALE 100,-75,-50: OVER -1: CLS: RANDOMISE DATE
160 x=1: y=2: n=4: DIM T(n,y)
170 :
180 REPEAT loop
190   FOR F=1 TO n
200     FOR J=x,y: T(F,J)=T(F,J)+RND(-1 TO 1)
210   END FOR F
220   :
230   FOR over_draw=1,2
240     LINE T(1,x),T(1,y) TO T(2,x),T(2,y) TO T(3,x),T(3,y)
250     LINE TO T(4,x),T(4,y) TO T(1,x),T(1,y) TO T(3,x),T(3,y)
260     LINE T(2,x),T(2,y) TO T(4,x),T(4,y)
270     i$=INKEY$(#1,1): IF i$<>'': OVER 0: GO TO 140
280   END FOR over_draw
290 END REPEAT loop
```

# Do you remember...? – Part 4

by Ralf Reköndt

## QL Cavern



Can you dodge the hazards waiting in the 50 caves and find the hidden gems? Find out when you take on the exciting challenge of QL Cavern.

QL Cavern sets a whole new standard in 'platform' type arcade games.

■ The action is set in a colourful underground cave system and, thanks to the QL's huge memory, the high-speed play is spread over a full 50 different settings. On the other side of this sheet, you'll find a selection of screen pictures showing just a few of the challenges of the cavern.

■ Each cave presents new hazards for the explorer, and you must use your skill at the controls to dodge them successfully.

■ On your journey you must walk or crawl along the underground passages, swim or travel by boat down the subterranean streams, and fly by jet-pack. You will also be able to make use of lifts, teleports and trampolines – but mind you don't step in the wrong place, or you risk losing a life.

■ Your objective is to find a hoard of 395 gems which has become scattered throughout the caves. When you have discovered each one, you must try to add it to your collection, but you'll find some of them very hard to reach . . .

■ Keyboard or joystick control.

Price:

**£12.95**

(includes comprehensive documentation)

Software written by:

**JMF**



5514

Time to continue with our series (the last few issues were so full that we had to pause this series). We are still hoping to get the promised information about the SPK from Ralf - Ed.

## QL Cavern

(on the lefthand side). The Boot is written using the SPK, the main part is written in assembler. The only game from Janko-Mrsik Flögel which was published under the Sinclair label. Two other games from the "BJ-Series" were published by Eidersoft. JMF wrote himself a special Game-Compiler to develop these games, but he does not want to publish it, unfortunately. The BOOT program is protected by the SPK and calculates some absolute memory addresses, which means that the game will only run on a QL.

## QL Meteor Storm

(below) Only the BOOT program is protected using the SPK. The program code itself can be started using RESPR..CALL or LRESPRed (on a QL). Nice "Shoot'em Up" game.

### A look round QL-Cavern

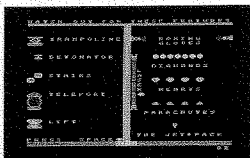

■ Watch out for these on your journey – you'll find plenty of hazards to dodge and encounter many helpful features.

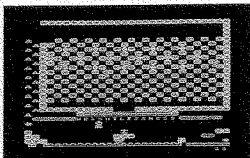
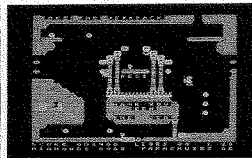

■ You'll have to use all your skill at the controls to reach each of the 50 caves. These pictures show just a few of the challenges you will meet on the way.

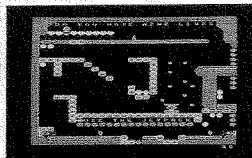
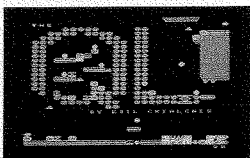

## QL Meteor Storm



An exciting all-action program for one or two players. The classic asteroid-shooting arcade game is now better than ever in this QL version.

Your mission is to pilot your spaceship through the meteor belt and destroy as many hazards as you can. There are three sizes of meteor and most successful strikes with your ship's missiles will simply break them into smaller bits. Only the smallest meteors can be destroyed completely and impact with any meteor will wreck your ship.

■ Another hazard lurks in the meteor belt. Ships from a rival space mining company patrol the area and will attack on sight, using space mines which seek out your ship and cannot be destroyed by your missiles.

■ As the game progresses, it becomes increasingly difficult to survive, with more meteors, more enemy ships and much faster space mines. In addition, your ship's automatic controls are influenced by the presence of so much dangerous rock and you cannot move quickly when you are surrounded by many large meteors.

■ The game has full sound effects and coloured graphics. It can be played with either a joystick or the cursor control keys and space bar of the QL.

Price:

**£12.95**

Software written by:

**Arakis**



5510

# QL Gardener



Choosing plants to suit your gardening needs is simple with QL Gardener. It will pick your best possible options from libraries of over 1100 plants.

QL Gardener is for anyone interested in growing plants. It will help you to choose the right flowers, trees and shrubs for every purpose around the garden, and you don't need to be an expert gardener or an expert with computers. QL Gardener provides a simple method for you to describe the plant you want, then searches its own extensive libraries for plants that meet your needs.

You can choose up to as many as 22 plant features. First, these allow you to make sure that you only buy plants which will thrive in your garden conditions. You can specify things like the soil type, climate, light levels, and other site features.

Next, you describe the plants themselves. Do you want flowers, and if so, what colour? How big should the plants be, and what shape? Should they have fruit? What colour foliage do you prefer? Do you want a seasonal display? . . . up to 22 options.

When you have entered your selection, you can ask for a list of all the suitable plants. When you have this, you just look them up in a catalogue or choose your favourites from a nursery. Overleaf, you'll see how easy it is to use QL Gardener.

Price:  
**£24.95**  
(includes comprehensive manual)

Software written by:  
**GORDIAN COMPUTING SERVICES**



5515

# QL Home Finance

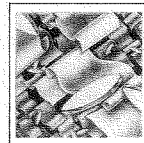

If you are used to keeping your home financial records on pieces of paper, then think about the advantages of transferring them to your QL.

The real power of computerised accounting is not just that all your data is in one place and can be accessed instantly – it's that you can get the answers to questions that would never be possible with records kept on paper.

QL Home Finance is the unique accounting system that's tailor-made for the needs of the home computer user. It's specially designed to provide everything you need to monitor your own personal spending and income.

QL Home Finance maintains separate accounts for all major types of expenditure, standing orders are processed automatically, and you can update your files or reconcile your statements whenever you want. Any time you want to check things through, QL Home Finance can provide the answers – instantly. You can sort your records under any heading, perform analyses or check a balance. QL Home Finance even shows who made each transaction.

The data is presented in an attractive display that's designed for clarity and ease of use. And if you have a printer, you can request a paper copy of your statement or analysis whenever you like. On the other side of this sheet, you'll find some sample screens and an explanation of how the program works.

Price:  
**£24.95**  
(includes comprehensive manual)

Software written by:



5513

## Using QL-Gardener

Even with a large number of gardening books, it would be almost impossible to find the answers to questions about plant selection which QL Gardener solves easily.

Computers can store large amounts of information, and QL Gardener contains details of as many plants as you would find only in one or more lengthy gardening reference books. But your QL does much more than any reference book, because it can sort the information the way you choose.

This means that you can ask the program, for example, to find all plants which have yellow flowers and which thrive in acid soils. You would find this hard to check with a reference book, but your QL will produce a list of suitable plants in seconds. This selection only specifies two characteristics of the plant, you could add many more – you might want a fast growth rate and spring flowering, perhaps – up to a total of 22 different options.

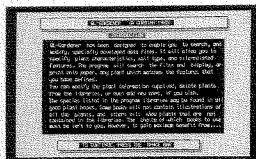

QL Gardener is simple to understand, and fun to use. A full introduction within the program and a comprehensive manual explain both how to use the program and the small amount of plant knowledge you need.

QL Gardener makes it easy for you to enter your instructions. Most are made by using the cursor keys to select from a menu displayed on the screen – so entries are quick and involve very little typing.

The main menu lets you choose between the various program functions. If you want to select some plant characteristics all you do is

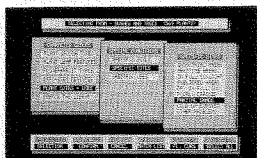

to position the cursor against this option and press the space bar to confirm your choice. As soon as you have done so a new menu will overlay the old one. This secondary menu lets you choose which group of features you want. Just select as before and you will be offered a more detailed series of choices.

It takes only seconds to enter all your preferences, then you can use the menu to request a list of suitable plants.



The program searches its libraries and lists the plants either on screen or on paper. The manual explains in detail how you can make your final choice from the list.

If you are interested in special plants which are not covered by the built-in libraries, QL Gardener lets you modify the information. You can also obtain extra, specialist lists to use with the program.

## Using QL-Home Finance

If you normally keep household accounts records on pieces of paper and store them all in one big file, you'll find that QL Home Finance is even easier to use.

The difference is that you can enter your records in any order you like. QL Home Finance automatically sorts them into the right place and arranges them by date. Once your records are on file, QL Home Finance can display them in any way you want, to make checking any of your home accounts even easier than reading a bank statement.

When you start a session with the program the first thing you have to do is to enter the date – QL Home Finance automatically uses this to prepare any statements or update standing orders. Then you just press a key to go instantly to the job you want.

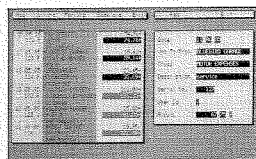

Suppose you want to enter some transactions against your bank account. QL Home Finance lets you set up different accounts for your bank, building society and so on – and sorts each record automatically.

All you have to do is to fill in a standard 'record card', shown on the right of the screen. The entry is sorted into the correct category and date order, and a statement of your account is displayed on the left of the screen. QL Home Finance copes with deposits as easily as it does with withdrawals, and you can even enter a code to show who made the transaction.

QL Home Finance makes it easy for you to enter transactions you use frequently. There's

no need to type the same words time and again. Just press a button and the record card flips through a list of standard entries, so you can pick the right one and fill in the amount.

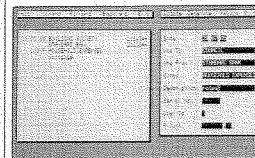

If you want to add standing orders or regular monthly payments, a couple of key presses will call up a special page for you to do this. Once again, you get a record card on which to make the entry – just specify who receives the money and which account it's drawn against. Enter the amount, set the start and finish dates, and the standing order will immediately be processed.

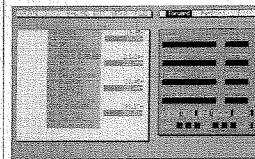

All the debits and credits are calculated on your statement page as soon as they have been entered. But QL Home Finance also makes it simple to process the information.

A couple more key presses take you to the analysis screen. Here you can call up the balance of any account, or analyse your income and expenditure.

## QL Gardener (SPK, BASIC)

A nice program for the home gardener. A large amount of information about plants, flowers and how to treat them.

## QL Home Finance (Assembler)

An easy to use home accounting program, but unfortunately not relocatably written, i.e. it only works on an original unexpanded 128k QL.

# JOCHEN MERZ SOFTWARE

**Kaiser-Wilh.-Str. 302 D-47169 Duisburg**  
**Tel. 0203 502011 Fax 0203 502012**  
**http://smsq.j-m-s.com smsq@j-m-s.com**

## SMSQ/E

QPC2 Version 3 with SMSQ/E ... now only **EUR 59,90**  
QPC2 Version 3 upgrade from Version 2 ... only **EUR 19,90**  
QPC2 Version 3 upgrade from Version 1 ... only **EUR 39,90**  
QPCPrint ... still only **EUR 39,90**

Please note that QPCPrint will be shipped on CD only.

QPC2 will also be shipped on CD by default now, as more and more systems (especially notebooks) do not have floppy disks drives built in anymore. If you prefer QPC2 on HD floppy disks, please state with your order. Free updates are available on Marcel's Website [www.KILGUS.net](http://www.KILGUS.net) If you prefer updates on CD or floppy disk, send in your master medium together with 4 international reply coupons to cover return postage, medium and packaging.

**SMSQ/E for ATARI or GoldCard or SuperGoldCard or QXL ...**  
now only **EUR 39,90**

Colour drivers now included as standard for (Super)GoldCard versions

For shipping inside Europe, EUR 3,- will be added for postage and packaging.  
For shipping outside Europe, EUR 6,- will be added for p & p.

### Current Versions of JMS Products

QPAC1 .....	V1.11	CueShell .....	V2.14
QPAC2 .....	V1.45	DISA .....	V3.04
FiFi .....	V4.31	QMAC .....	V1.06
Success .....	V2.04	QTYP .....	V2.17
QSpread .....	V4.04	QMON/JMON .....	V2.14
BASIC Linker .....	V1.25	Agenda .....	V1.09
QMAKE .....	V4.31	(In cases where various programs are on a floppy disk (e.g. QPAC1 or QMON/JMON, the version number given here is the floppy disk format name version number!)	
QSUP .....	V4.00		
WinEd .....	V1.26		
QD .....	VB.01		

**If you wish to place your order via internet, please do not send your credit card details in an email!**  
**Please use the secure contact form on the SMSQ homepage: [SMSQ.J-M-S.COM](http://SMSQ.J-M-S.COM)**  
**We accept VISA, MasterCard and Diners Club!**

Just after putting the last column to bed I went off to attend the Byfleet QL Workshop. The attendance was rather sparse although the quality of those visiting was high and I did have several good conversations with users, Quanta Committee members and traders. For me, the whole business of going to these shows is more social than commercial - which is just as well given the low number of visitors and subsequent low sales.

This show was the last one they will have at this venue so it was a rather sad event. Some of the people I met at the first of the shows that I have attended over the last 10 years are now no longer with us and I am sure that some of the people who were not there this time only missed out because of bad health or sheer age. It was, however, good to see that some of the younger visitors to the show were very enthusiastic and positive about their QL involvement.

As always there was talk of how we could improve the attendance and enthusiasm for QL Workshops. To me that whole thing hinges upon the second word, 'Workshops'. When the QL was in its heyday many of the people who attended did so to set up their systems and show off the stuff they were doing as well as to buy new hardware and software. With very little of the latter two items on the cards, it was good to see that some of the people who were there did set up systems and show off their current obsessions. I think, if we want to extend and improve the use of QL systems and the numbers or users we need, firstly, to apply ourselves to developing new programs and to making more of a Workshop at the shows. QBranch is always happy to consider new programs so, if you have anything you think others may use, send it to me.



## Quanta and the Workshop System

These workshops are not shows in the sense that you turn up to be entertained - although some of our QL enthusiasts can be quite entertaining, sometimes unintentionally. It should be based on feedback and participation by its members. Some of the QL Users have a vast amount of knowledge and a QL show is one way to tap into that knowledge productively.

There is often a lot of talk about building the shows up to attract people to attend but I think maybe getting people to interact would be a more attractive proposition. You can rely on Tony Firshman being there for most shows to help out with hardware problems and Geoff Wicks is also usually available to discuss software. Even I can offer help and advice so why not make the effort to attend a show and see what you can gain? No purchase necessary, as they say.

## No Commercial Potential

It comes as a fitting point, straight after writing that piece, Geoff Wicks announced that Just Words would no longer be a commercial organisation and that all of the software previously marketed by him would become freeware - subject only to the usual costs of copying and supply.

It was good to see that this announcement did not mean that he was no longer planning to attend shows and was not planning to close operations completely.

I have often touched on the subject of commercial versus free software in this column and I am afraid that I am going to have to talk about it again

in this regard. I have never had any problem with people wanting to make the fruits of their labours free for anyone to use and I have happily used

some of it in the past. As you all probably know, I have been fairly scathing about the tendency some authors show towards the excessively anal rulebook. The insistence on including source code along with the program does seem to have relaxed, for some at least, to the state in which, putting the website address where the curious can download the code, will suffice. I don't know if other authors have relaxed the rules about not even charging for copying and return posting & packing. If not they should do so in order to get their efforts to a wider audience.

It is evident that, over the last year at least, it has been the people like Dilwyn Jones who have contributed the most software to the scene. (Hey look Dilwyn, I have given you a mention without a tasteless joke attached!). I do not belittle the efforts and products of the freeware authors at all. Dilwyn's programs last year were very good but I really do not want the QL scene to become a completely free platform. I would like to see some more ambitious projects being tackled and I feel that the thought that, after a few months of hard coding, there might be a small tinkle of loose change heading your way, might tempt people into doing something. No-one expects to get rich here or even cover the time spent out but sometimes, just sometimes, earning enough for a celebratory drink might just be the icing on the cake.

## Backup Blues

Linking nicely to that section I found myself looking at backup software over the last few weeks as I wrote the current 'Start Here' section for this magazine. There are four backup utilities available for QDOS/SMSQ systems and I looked at all four while I was writing the piece. Since it was not meant to be a software review I did not go into writing about how they worked and how to use them but I did run them up and look at the way they approached the situation. I realised that we do not have a really good looking, easy to use, backup utility.

All but one of the four are non pointer driven and all four really need a bit of work to get them up to scratch. QBranch currently keeps the Knight Safe 3 on its books but the current version does not really support the high colour SMSQ/E and does lock up under the current version. Mark Knight, the author, is no longer involved (although I am sure I could reach him should I have royalties to pass on). When we last spoke he said he was not interested in doing any more work on it.

Norback, the one PE program in the batch, does work although it has one drawback in that it will crash out of the backup if it hits a file it considers to be corrupt. This can be very frustrating. Apart from that it is a very good program and has stood the test of time well. Norman Dunbar did tell me that Winback had a 'problem with something in SMSQ/E' but he could not remember what that was now. I do remember using that ages ago and it was a good program too but I did not try it out this time round.

If there is someone out there looking for a good project for the long winter nights then I suggest that this might be it. I don't care if you want to do it as a freebe or as a commercial/shareware option.

I would like to suggest a few areas it should cover:

1. Compressed archive - one of the best features of The Knight Safe was its ability to produce a compressed set of files keeping the backup small.
2. Restore - it should be able to retrieve one file from an archive if needed.
3. 'Incrementality' - it should be able to find files changed since the last backup and ignore those that have not changed.
4. It should stop when it finds a corrupted file and give the user the option of ignoring that file and continuing the backup - logging the bad file.
5. It should keep a log of which files it has backed up, which it has ignored and which it considers corrupt.
6. It should be simple to use.
7. It should look good.

If you think that is not enough to be going on with then how about throwing in a disk defragmentor, utility to compare and flag similar files in different directories and delete corrupt files that the usual range of file managers cannot touch.

Now off you go and write it.

## Peter Fox - Clocking Off

One person who can be relied upon to toss a spaniard into the works at a show is Peter Fox - and I mean that in a positive way. He can find problems that no-one else can and he did well at the Byfleet show.

We installed a new battery on his Super Gold Card. Simple procedure;- just remove the old one checking to see where the '+' sign embossed on

the battery is and then install the new one making sure that it is

- a) Aligned the same way
- b) It has no bent legs (only two are required - the other two are for stability)
- c) It is firmly in place.

Then re-assemble the unit and boot the system. After that all you have to do is reset the clock and the Auto Boot facility if you need it. Well we did this and after a little struggle because the new battery seemed to have slightly thicker legs than its predecessor, it all went back together. We watched as Peter set the clock - only to find it was twelve hours out. Not a big problem you may think but it would not get set correctly. The Minerva clock - seen at startup, was correct and in 24hr mode but the QL clock, viewed from SMSQ/E stubbornly refused to show the same time.

At first it was just me standing there adding 'useful' comments but we soon attracted a small gathering with John Hall, Per Witte, Phil Jordan and Tony Firshman all staring uselessly at Peter's recalcitrant timepiece. I mean how many QL experts does it take to change a QL clock?

I would like to say that we solved the problem but, by the time we left the building, the clock was still stubbornly twelve hours out. Anyone have any ideas about this?

## Perchance Two Screens

In my Start Here article on display setup and in other articles I have mentioned the option which appears in the QPC2 configuration screen and usually reads 'Primary Display Driver'. I had always described the function of this setting to people as selecting which graphics display to use when you have two screens connected to the PC. This was what I believed it did.

At work I use two screens and, in an idle moment the other day, I decided to set QPC2 to appear on the smaller screen to the right. I clicked on this option and all it said was 'Primary Display Driver'. I checked the Windows display options and that definitely had two display adaptors shown which were both configurable. I tried a few different options and could make no sense of it so I emailed Marcel. This was his reply:

'This stems back from the Win95 times, when dual-screen was different from today. These are actually 2 different concepts. Back then you had

2 graphics cards with 2 different drivers which were completely separate. That's what you can select in QPC.

Today Windows manages multiple view screens like a big desktop, so from the application point of view (or rather, Direct X POV), there is only one graphics card present, no matter how many monitors are attached. The option is pretty useless all in all, especially today, but it was a possible choice, so I implemented it.'

I do remember setting up a two monitor system using two different graphics cards in Windows 98 when I ran the shop back in 2000 and I think it was then that I first looked at the Display options in QPC2. So that is that laid to rest then. You can use QPC2 on either screen on a modern system, of course, just by dragging it there so the option is not really needed any more.

## Vista Packed

By the time you read this the latest incarnation of Windows will have made it to the shops and be shipping on many of the PCs that are for sale. It amused me to note that, in the reviews I have read so far much of the excitement has been to do with the cosmetic changes and very little is being said about the actual practicality of the system.

Many of the reviewers have enthused about the new 'Aero Glass' interface in which the windows themselves are 'almost transparent'. I thought that was the definition of a window after all - a space in a solid structure that you can look through. Seems that Bill Gates' team has only just found the dictionary and thought 'oh, that is what it should do'. This is almost as if the inventors of the original windows that were placed in walls back in the mists of time proudly announced their new 'Wall Interface' and filled them with Wood leaving people puzzled why it was not just a wall.

A lot of people will be comparing this to the MAC interface design but, in reality it is all just frippery. Computer interfaces are just fashion accessories after all and the important thing about it is how much difference does it make to the actual processes that you may want to run on the computer itself. This seems down to the age old argument about whether you should use a mouse or not/have icons on the screen or even use more than four colours. It is just individual preference after all.



## Safe and Sound

The thing that will be exercising the minds of many people will be the security issue. We have recently seen a change of emphasis in that area. A shift from small time, back room hackers and virus writers producing code for fun or out of a sense of teenage dispepsia just to screw the world (or at least the Windows World) up. These days there is more malevolence at work.

Many hackers are now in the pay of underworld gangs trying to set up an army of 'netbots' and 'spambots' - infected computers that can be used in denial of service attacks and as generators of the vast swarm of spam that swamps the internet. Whereas, in the past, all of this has been directed against the reviled world of Gates and Co, since it is now driven by financial imperatives, other systems are finding that the flaws and holes, which have sat undetected or, at least ignored, in their code are now being exposed and need patching. Will the new Windows be any better than its forbears? Who can say? In the end the biggest security threat is sitting right there with his/her hands on the keyboard and that won't change no matter what system is on the screen.

## Hardware and Software Support

We have been running a Beta version of Vista at work for some time but it is only on a spare disk in our test rig. In our experience so far there is a lot of hardware that either doesn't work or is not well provided for. I have not had a chance to try much software on it yet but that does bring me on to my next point.

The first thing I did when I got a few spare moments on Vista was to try QPC2 out. I found, to my surprise, that it did not work. This is the first version of Windows on which whatever version of QPC2 that is current at the time has not 'just worked'. I was about to report this to Marcel when another QL User (Per Witte I think) did so on the users list. Just as I was putting the finishing touches to this column I thought I would ask Marcel for a comment on it.

I wrote:

*I am just putting the finishing touches to BoW for the next magazine and I mention Vista at the end. Any idea when the new QPC2 will be ready for it or any comments you would like me to quote about it?*

*Oh, it isn't released yet? Then I should probably do that, thanks for reminding me :-)*

*I have mentioned that, since QPC2 came out, this is the first time it has not been able to run on a new version of Windows without a change and that the problem was that M\$ removed a DLL from its networking library. Anything else you would like to add?*

*They removed a function from one of their networking DLLs. This function was never officially documented, but I used it nonetheless. So in principle I am to blame, but considering to what great lengths they go to keep everything as compatible as possible I was a bit amazed this actually happened.*

So now you know - as always a new version of QPC2 should be with you before you know you need it!

## Vista Startup

One last thing before I go. Vista is also trumpeting that you can now use Flash Ram as part of its operating memory. Well, well - we have had that on our QLs for ages. It is called ROMDisq. Time for Tony to sue Microsoft for intellectual property rights.

## 50 Pages this time "only"

No, no, we are not making up for the cover disk and we do not want to save pages to compensate the postage increase!

We have waited until last minute for material. We do not want to delay the delivery of this issue, therefore we have to accept it the way it is.

As we will try to get the next issue out to you for the Hove Show, please send material for the next issue to us as soon as possible - and as much as possible!

So, please send in YOUR article so that the next issue will be 60 pages again ... or even more!

# The QL Show Agenda

## QL Meetings in Eindhoven

**Saturday, 24th of March 2007, 10:00 to 16:00**  
**Pleincollege St. Joris, Roostenlaan 296**

Thanks to the organiser, Sjef van de Molengraaf, the meetings at Eindhoven continue. Same venue as always (but a new, nice, large room straight on when you get into the main hall!) J-M-S will be there, as always. I am sure we will figure out on "international" meeting where the English dealers (and more international visitors) will attend. If it will be the March meeting, then QL Today will be the source for this information, as always.

Further meetings will be held in June and October.

## The Hove Quanta AGM & Workshop

**Sunday, 15th of April 2007, 10am to 4pm**  
**Portslade Townhall, Victoria Road, Portslade, Sussex**



Welcome to the 2007 Hove Quanta AGM & Workshop. This year we once again hope to have several interesting talks to engage your interest. Details will be announced closer to the date. We are arranging a dinner on the Saturday evening for those staying overnight. This will be held at Bom Banes Restaurant [www.bom-banes.co.uk](http://www.bom-banes.co.uk)

This is a most unusual venue and should be a good evening.

Please contact [sales@qbranch.demon.co.uk](mailto:sales@qbranch.demon.co.uk) to book a place.

All this, the usual good food at the venue and a day by the seaside.

A list of hotels will be posted soon.

What more could you ask for?

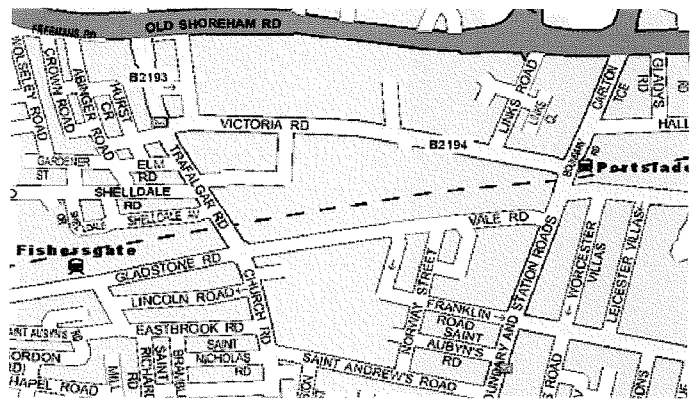

# The Next Issue

We plan to have the next issue ready for you Middle of April - for the Hove show (please see above - and the Quanta ad in the middle of this issue).

As always, it depends on how quickly we will get reviews, articles etc.

The more we get, the sooner we get it, the quicker the next issue will be in your hands.